

OWNER'S MANUAL



TOHATSU

Feel the Wind™

BFT 115A
BFT 150A

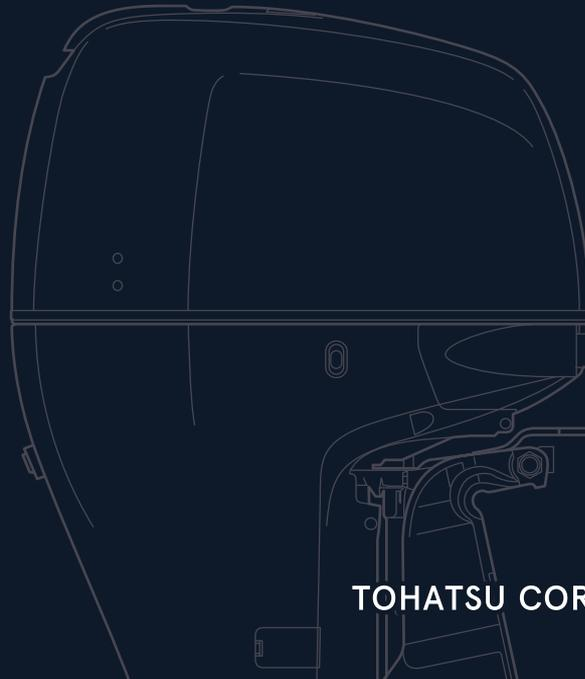

TOHATSU CORPORATION



 **WARNING**

The engine exhaust from this product contains chemicals known to the State of California to cause cancer, birth defects, or other reproductive harm.

California Proposition 65

This product contains or emits chemicals known to the state of California to cause cancer, birth defects or other reproductive harm

Keep this Owner's Manual handy, so you can refer to it at any time. This Owner's Manual is considered a permanent part of the outboard motor and should remain with the outboard motor if resold.

INTRODUCTION

Congratulations on your selection of a TOHATSU outboard motor. We are certain you will be pleased with your purchase of one of the finest outboard motors on the market.

We want to help you get the best results from your new outboard motor and to operate it safely. This manual contains information on how to do that; please read it carefully.

As you read this manual you will find information preceded by a **NOTICE** symbol. That information is intended to help you avoid damage to your outboard motor, other property, or the environment.

We suggest you read the warranty policy to fully understand its coverage and your responsibilities of ownership.

When your outboard motor needs scheduled maintenance, keep in mind that your TOHATSU dealer is specially trained in servicing TOHATSU outboard motors. Your TOHATSU dealer is dedicated to your satisfaction and will be pleased to answer your questions and concerns.

Best Wishes,
Tohatsu Corporation

INTRODUCTION

A FEW WORDS ABOUT SAFETY

Your safety and the safety of others are very important. And using this outboard motor safely is an important responsibility.

To help you make informed decisions about safety, we have provided operating procedures and other information on labels and in this manual. This information alerts you to potential hazards that could hurt you or others.

Of course, it is not practical or possible to warn you about all the hazards associated with operating or maintaining an outboard motor. You must use your own good judgment.

You will find important safety information in a variety of forms, including:

- **Safety Labels** – on the outboard motor.
- **Safety Messages** – preceded by a safety alert symbol  and one of three signal words, DANGER, WARNING, or CAUTION.

These signal words mean:

 **DANGER**

You **WILL** be **KILLED** or **SERIOUSLY HURT** if you don't follow instructions.

 **WARNING**

You **CAN** be **KILLED** or **SERIOUSLY HURT** if you don't follow instructions.

 **CAUTION**

You **CAN** be **HURT** if you don't follow instructions.

- **Safety Headings** – such as *IMPORTANT SAFETY INFORMATION*.
- **Safety Section** – such as *OUTBOARD MOTOR SAFETY*.
- **Instructions** – how to use this outboard motor correctly and safely.

This entire book is filled with important safety information – please read it carefully.

CONTENTS

| | | | |
|--|----|--|----|
| OUTBOARD MOTOR SAFETY | 7 | Top-Mount Type | |
| IMPORTANT SAFETY INFORMATION | 7 | Ignition Switch | 22 |
| SAFETY LABEL LOCATION | 9 | Emergency Stop Switch Clip and Emergency | |
| CONTROLS AND FEATURES | 10 | Stop Switch | 22 |
| CONTROL AND FEATURE IDENTIFICATION | | Gearshift/Throttle Control Lever | 23 |
| CODES | 10 | Fast Idle Button | 25 |
| HOW TO DETERMINE WHICH DIRECTION | | Common Controls | |
| THE PROPELLER SHAFT ROTATES | 10 | Power Trim/Tilt Switch | 26 |
| COMPONENT AND CONTROL LOCATIONS ... | 11 | Power Tilt Switch | 27 |
| CONTROLS | 15 | Manual Relief Valve | 27 |
| Side-Mount Type | | Tilt Lock Lever | 27 |
| Ignition Switch | 15 | TRL (Trolling) Control Switch..... | 28 |
| Emergency Stop Switch Clip and Emergency | | Engine Cover Latch | 28 |
| Stop Switch | 15 | Trim Tab | 29 |
| Gearshift/Throttle Control Lever | 16 | INSTRUMENTS | 29 |
| Fast Idle Lever | 17 | Trim Meter (optional equipment) | 29 |
| Panel-Mount Type | | Tachometer (optional equipment) | 29 |
| Ignition Switch | 18 | NMEA Interface Coupler | 30 |
| Emergency Stop Switch Clip and Emergency | | Operating Hour Notification System | 30 |
| Stop Switch | 19 | | |
| Gearshift/Throttle Control Lever | 20 | | |
| Fast Idle Button | 21 | | |

CONTENTS

| | | | |
|--------------------------------------|----|------------------------------------|----|
| INDICATORS | 33 | OPERATION | 39 |
| Alternator (ACG) Indicator | 33 | SAFE OPERATING PRECAUTIONS | 39 |
| Malfunction Indicator | 33 | BREAK-IN PROCEDURE | 39 |
| Oil Pressure Indicator | 34 | FUEL PRIMING | 40 |
| Overheat Indicator | 34 | INFREQUENT OR OCCASIONAL USE | 40 |
| Cooling System Indicator | 35 | STARTING THE ENGINE | 41 |
| OTHER FEATURES | 35 | Side-Mount Type | 41 |
| Water Separator Buzzer | 35 | Panel-Mount Type | 44 |
| Rev Limiter | 36 | Top-Mount Type | 46 |
| Anodes | 36 | STOPPING THE ENGINE | 49 |
| Fuel Priming Bulb | 36 | Emergency Engine Stopping | 49 |
| BEFORE OPERATION | 37 | Normal Engine Stopping | 50 |
| ARE YOU READY TO GET UNDERWAY? | 37 | GEARSHIFT AND | |
| IS YOUR OUTBOARD MOTOR | | THROTTLE OPERATION | 51 |
| READY TO GO? | 37 | STEERING | 52 |
| | | CRUISING | 53 |
| | | Trolling Speed Control | 55 |
| | | TRIM TAB | 56 |
| | | SHALLOW WATER OPERATION | 56 |
| | | MOORING, BEACHING, LAUNCHING | 57 |
| | | MULTIPLE OUTBOARD MOTORS | 58 |

CONTENTS

| | | | |
|--|----|--|----|
| SERVICING YOUR OUTBOARD MOTOR | 59 | REFUELING | 77 |
| THE IMPORTANCE OF MAINTENANCE | 59 | FUEL RECOMMENDATIONS | 77 |
| MAINTENANCE SAFETY | 60 | Fuel Filter Inspection and Replacement | 78 |
| TOOL KIT and OWNER'S MANUAL | 61 | Water Separator Inspection and Service | 81 |
| SPARE EMERGENCY STOP SWITCH CLIP | 61 | Anode Replacement | 83 |
| MAINTENANCE SCHEDULE | 62 | Propeller Replacement | 83 |
| TRIM TAB ADJUSTMENT | 64 | CLEANING AND FLUSHING | 85 |
| MANUAL RELIEF VALVE | 65 | Cleaning and Flushing | 85 |
| ENGINE COVER REMOVAL AND | | STORAGE | 87 |
| INSTALLATION | 65 | Fuel | 87 |
| Engine Oil Level Check | 66 | Engine Oil | 89 |
| Engine Oil Change | 67 | HOISTING THE OUTBOARD MOTOR | 90 |
| Oil Filter Change | 69 | STORAGE PRECAUTIONS | 90 |
| Engine Oil Recommendations | 70 | REMOVAL FROM STORAGE | 91 |
| Lubrication Points | 71 | | |
| Spark Plug Service | 73 | | |

CONTENTS

| | | | |
|--|-----|---|-----|
| TRANSPORTING | 92 | TECHNICAL INFORMATION | 105 |
| WITH OUTBOARD MOTOR | | Serial Number Locations | 105 |
| INSTALLED ON BOAT | 92 | Battery | 106 |
| WITH OUTBOARD MOTOR | | Emission Control System Information | 106 |
| REMOVED FROM BOAT | 92 | Star Label | 109 |
| | | Specifications | 111 |
| TAKING CARE OF UNEXPECTED PROBLEMS | 93 | CONSUMER INFORMATION | 113 |
| ELECTRIC STARTER WILL NOT OPERATE | 93 | Emission Control System Warranty | 113 |
| ENGINE WILL NOT START | 94 | | |
| HARD STARTING OR STALLS AFTER | | INDEX | 118 |
| STARTING | 96 | | |
| ENGINE OVERHEATS | 97 | | |
| FUSES | 98 | | |
| Electric Starter Will Not Operate | 98 | | |
| Battery Will Not Charge | 98 | | |
| Fuse Replacement | 98 | | |
| OIL PRESSURE INDICATOR TURNS OFF AND | | | |
| ENGINE SPEED IS LIMITED | 100 | | |
| OVERHEAT INDICATOR COMES ON AND | | | |
| ENGINE SPEED IS LIMITED | 101 | | |
| WATER SEPARATOR BUZZER SOUNDS | 103 | | |
| SUBMERGED OUTBOARD MOTOR | 103 | | |

OUTBOARD MOTOR SAFETY

IMPORTANT SAFETY INFORMATION

TOHATSU BFT115A and BFT150A outboard motors are designed for use with boats that have a suitable manufacturer's power recommendation. Other uses can result in injury to the operator or damage to the outboard motor and other property.

Most injuries or property damage can be prevented if you follow all instructions in this manual and on the outboard motor. The most common hazards are discussed in this chapter, along with the best way to protect yourself and others.

Operator Responsibility

- It is the operator's responsibility to provide the necessary safeguards to protect people and property. Know how to stop the engine quickly in case of emergency. Understand the use of all controls.
- Stop the engine immediately if anyone falls overboard, and do not run the engine while the boat is near anyone in the water.
- Always stop the engine if you must leave the controls for any reason.
- Attach the emergency stop switch lanyard securely to the operator.
- Always wear a PFD (Personal Flotation Device) while on the boat.
- Familiarize yourself with all laws and regulations relating to boating and the use of outboard motors.
- Be sure that anyone who operates the outboard motor receives proper instruction.
- Be sure the outboard motor is properly mounted on the boat.
- Do not remove the engine cover while the engine is running.

OUTBOARD MOTOR SAFETY

Refuel With Care

- Gasoline is extremely flammable, and gasoline vapor can explode. Refuel outdoors, in a well-ventilated area, with the engine stopped. Never smoke near gasoline, and keep other flames and sparks away.
- Refuel carefully to avoid spilling fuel. Avoid overfilling the fuel tank.
- After refueling, tighten the filler cap securely. If any fuel is spilled, make sure the area is dry before starting the engine.

Carbon Monoxide Hazard

Exhaust contains poisonous carbon monoxide, a colorless, odorless gas. Breathing carbon monoxide can cause loss of consciousness and may lead to death.

If you run the engine in an area that is confined, or even partly enclosed, the air you breathe could contain a dangerous amount of exhaust gas.

Never run your outboard inside a garage or other enclosure.

SAFETY LABEL LOCATION

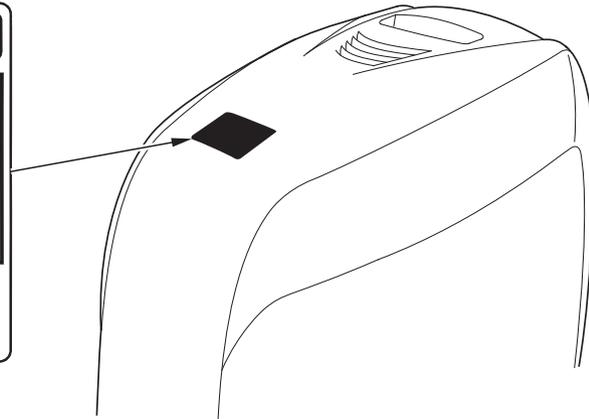

The label shown here contains important safety information. Please read it carefully. This label is considered a permanent part of your outboard motor. If the label comes off or becomes hard to read, contact an authorized TOHATSU dealer for a replacement.

CONTROLS AND FEATURES

CONTROL AND FEATURE IDENTIFICATION CODES

| Model | BFT115A | | | BFT150A | | |
|-----------------------------------|---------------------|----|-----|---------|----|-----|
| | LA | XA | XCA | LA | XA | XCA |
| Type | | | | | | |
| Transom Height (Shaft Length) | 20.0 in (508 mm) | • | | • | | |
| | 25.0 in (635 mm) | | • | • | • | • |
| Standard Rotating Propeller Shaft | • | • | | • | • | |
| Counterrotating Propeller Shaft | | | • | | | • |
| Power Trim/Tilt | • | • | • | • | • | • |

Refer to this chart for an explanation of the Type Codes used in this manual to identify control and feature applications.

TYPE CODE (example)

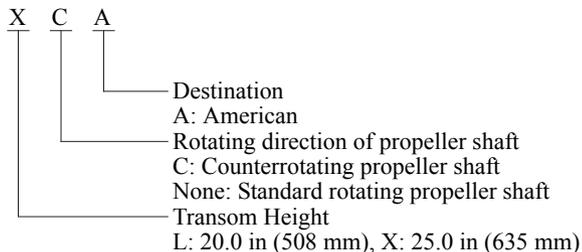

HOW TO DETERMINE WHICH DIRECTION THE PROPELLER SHAFT ROTATES

The direction the propeller shaft rotates can be determined based on whether or not the shaft has a groove.
 With groove: Counterrotating
 Without groove: Standard rotating

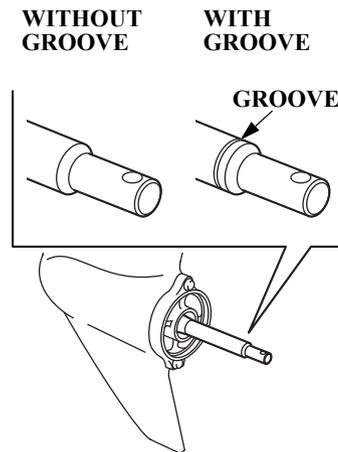

CONTROLS AND FEATURES

COMPONENT AND CONTROL LOCATIONS

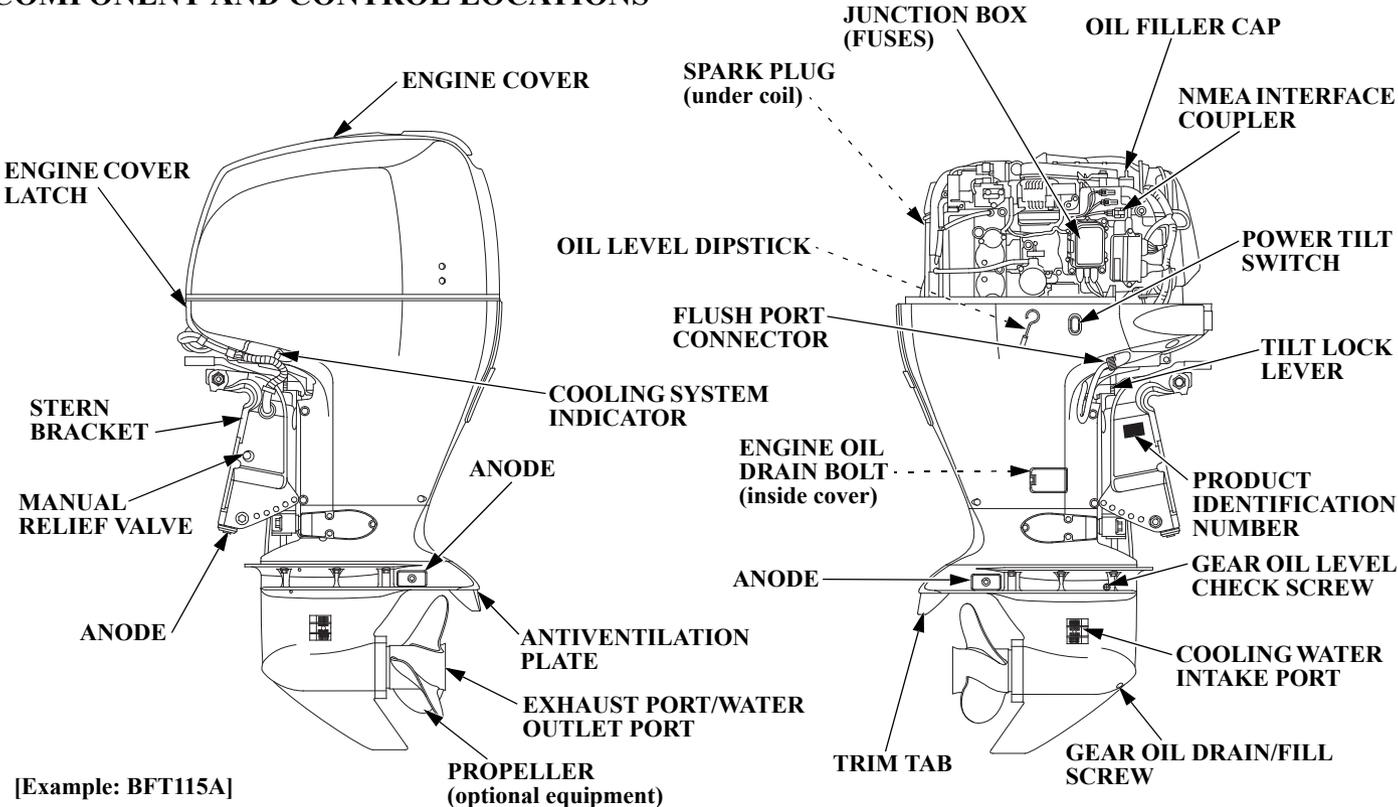

CONTROLS AND FEATURES

Remote Controls (optional equipment)

Side-Mount Control Type

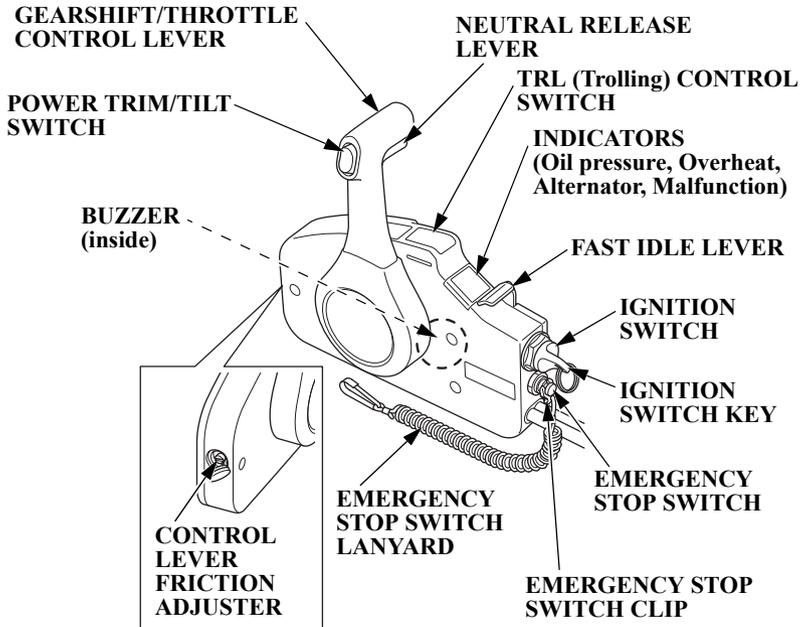

Panel-Mount Control Type

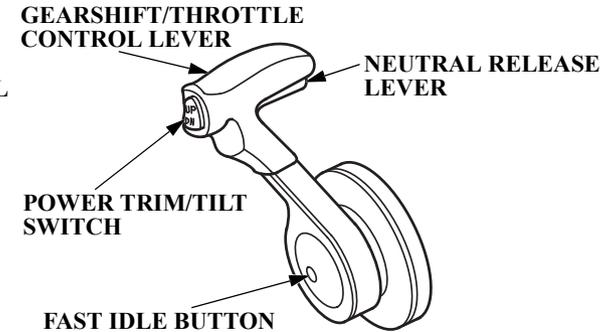

Control Panel (for Panel-Mount Type)

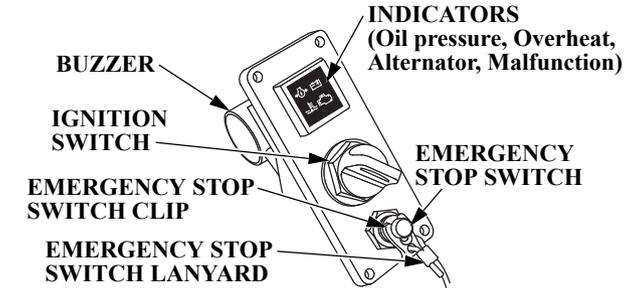

CONTROLS AND FEATURES

Top-Mount Type (Single Outboard Motor Type)

GEARSHIFT/THROTTLE
CONTROL LEVER

POWER TRIM/TILT
SWITCH

FAST IDLE BUTTON

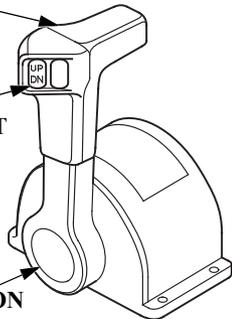

(Dual Outboard Motor Type)

GEARSHIFT/THROTTLE
CONTROL LEVERS

POWER TRIM/TILT
SWITCH (RIGHT)

POWER TRIM/TILT
SWITCH (LEFT)

FAST IDLE BUTTON

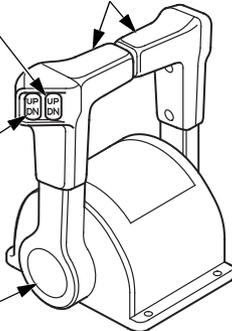

Control Panel (Top-Mount Single Type)

BUZZER

INDICATORS
(Oil pressure, Overheat,
Alternator, Malfunction)

IGNITION
SWITCH

EMERGENCY STOP
SWITCH CLIP

EMERGENCY
STOP SWITCH

EMERGENCY STOP
SWITCH LANYARD

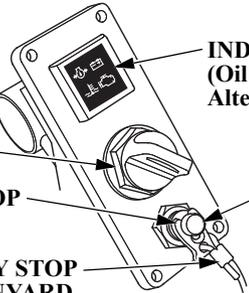

(for Top-Mount Dual Type)

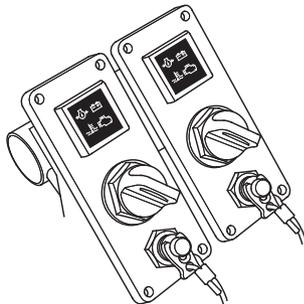

CONTROLS AND FEATURES

Instruments (optional equipment)

Tachometer

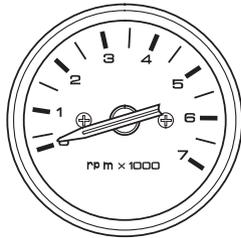

Trim Meter

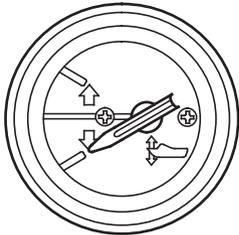

Trolling Control Switch Panel

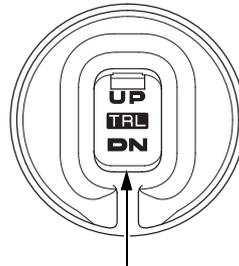

TRL (Trolling)
CONTROL SWITCH

CONTROLS

Side-Mount Type

Ignition Switch

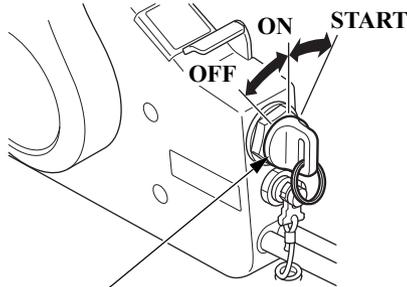

IGNITION SWITCH

The ignition switch controls the ignition system and the starter motor.

Turning the ignition switch key to the START position operates the starter motor. The key automatically returns to the ON position when released from the START position.

The engine will not start unless the gearshift/throttle control lever is in the N (neutral) position (p. 41) and the emergency stop switch clip is in the emergency stop switch.

Turning the ignition switch to the OFF position stops the engine.

Emergency Stop Switch Clip and Emergency Stop Switch

EMERGENCY STOP SWITCH

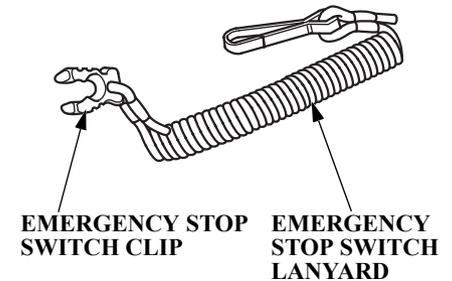
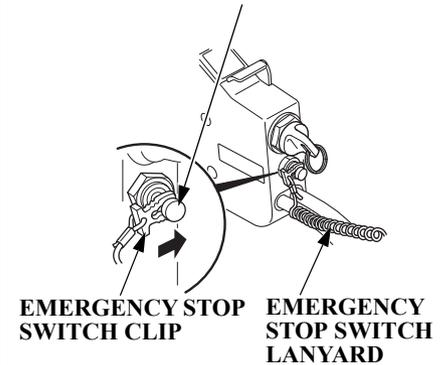

CONTROLS AND FEATURES

The emergency stop switch clip must be inserted in the emergency stop switch in order for the engine to start and run. The emergency stop switch lanyard must be attached securely to the operator or to the operator's PFD (Personal Flotation Device).

When used as described, the emergency stop switch clip and emergency stop switch lanyard system stops the engine if the operator falls away from the controls.

A spare switch clip (optional equipment) can be stored in the tool bag.



SPARE SWITCH CLIP
(optional equipment)

Gearshift/Throttle Control Lever

GEARSHIFT/THROTTLE CONTROL LEVER

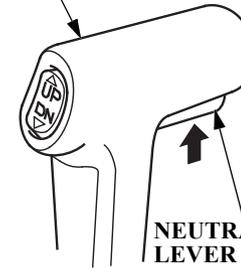

The gearshift/throttle control lever controls engine speed and selects F (forward), N (neutral), or R (reverse) gears.

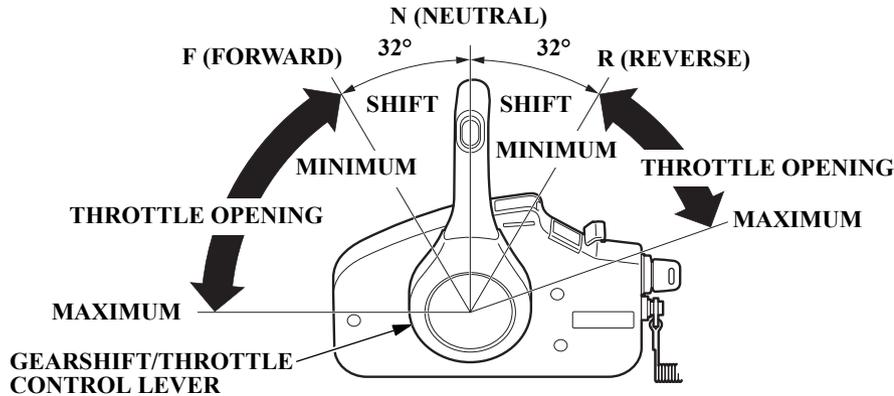

Moving the control lever 32° from N (neutral) selects the gear, and further movement increases engine speed.

The control lever automatically locks itself in the N (neutral) position. To move the lever out of the N (neutral) position, you must squeeze the neutral release lever on the underside of the lever handle.

A friction adjuster adjusts the operating resistance of the control lever. Refer to p. 52.

Less friction allows easier control lever movement. More friction helps to hold a steady throttle setting while cruising.

Fast Idle Lever

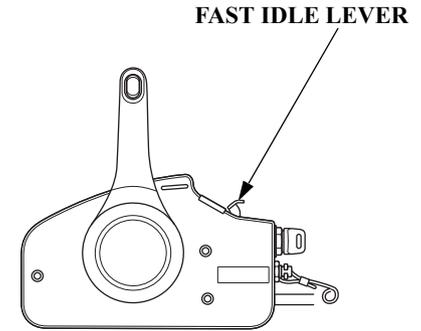

Use the fast idle lever to accelerate engine warm-up after starting the engine. Do not use the fast idle lever when starting the engine.

See page 43 for engine warm-up instructions.

CONTROLS AND FEATURES

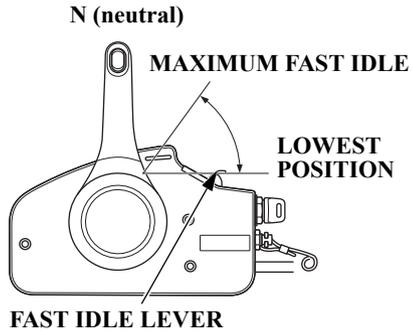

The fast idle lever allows you to increase the idle speed only when the control lever is in the N (neutral) position. Place the fast idle lever in its lowest position to cancel the fast idle and return the control lever to normal operation.

Panel-Mount Type

Ignition Switch

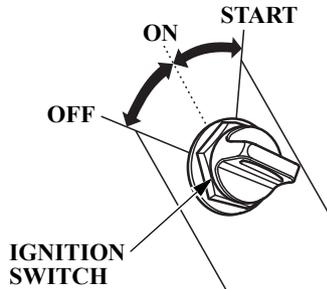

The ignition switch controls the ignition system and the starter motor.

Turning the ignition switch key to the START position operates the starter motor. The key automatically returns to the ON position when released from the START position.

The engine will not start unless the gearshift/throttle control lever is in the N (neutral) position (p. 44) and the emergency stop switch clip is in the emergency stop switch.

Turning the ignition switch to the OFF position stops the engine.

Emergency Stop Switch Clip and Emergency Stop Switch

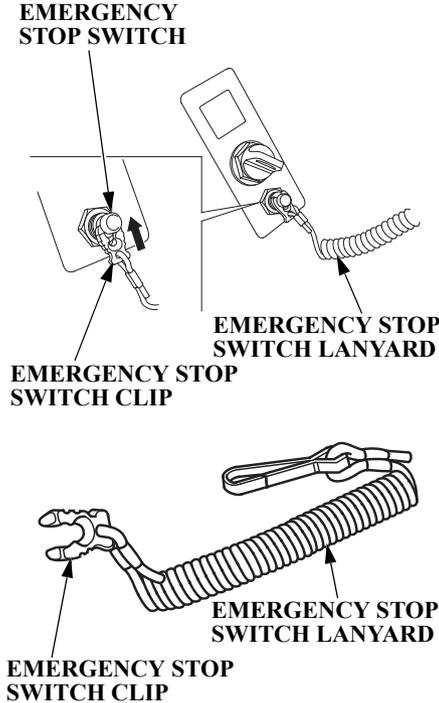

The emergency stop switch clip must be inserted in the emergency stop switch in order for the engine to start and run. The emergency stop switch lanyard must be attached securely to the operator or to the operator’s PFD (Personal Flotation Device).

When used as described, the emergency stop switch clip and emergency stop switch lanyard system stops the engine if the operator falls away from the controls.

A spare switch clip (optional equipment) can be stored in the tool bag.



**SPARE SWITCH CLIP
(optional equipment)**

CONTROLS AND FEATURES

Gearshift/Throttle Control Lever

GEARSHIFT/THROTTLE CONTROL LEVER

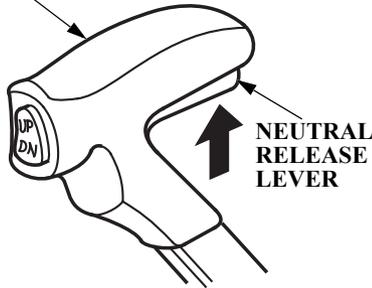

The gearshift/throttle control lever controls engine speed and selects F (forward), N (neutral), or R (reverse) gears.

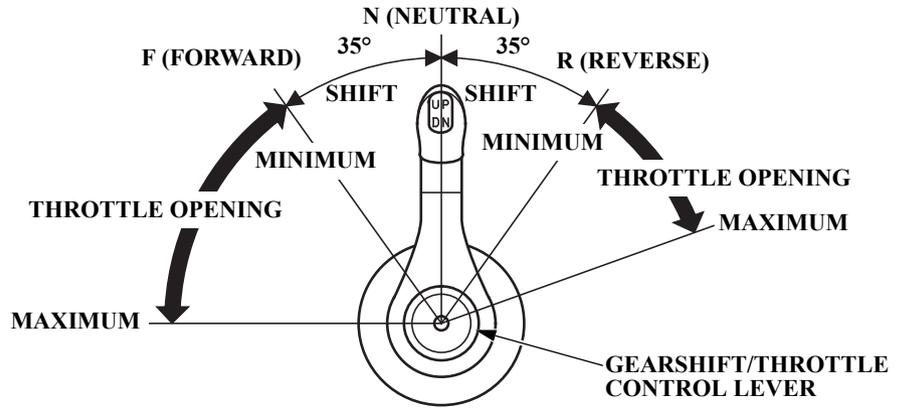

Moving the control lever 35° from N (neutral) selects the gear, and further movement increases engine speed.

The control lever automatically locks itself in the N (neutral) position. To move the lever out of the N (neutral) position, you must squeeze the neutral release lever on the underside of the lever handle.

A friction adjuster near the base of the control lever adjusts the operating resistance of the control lever. Refer to p. 52.

Less friction allows easier control lever movement. More friction helps to hold a steady throttle setting while cruising.

Fast Idle Button

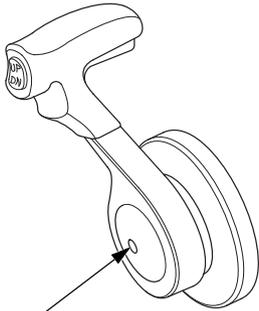

FAST IDLE BUTTON

Use the fast idle button to accelerate engine warm-up after starting the engine. Do not use the fast idle button when starting the engine.

See page 45 for engine warm-up instructions.

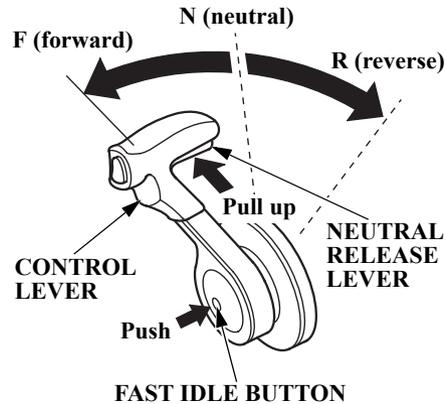

The fast idle button allows you to increase the idle speed without engaging the drive gears. Move the control lever forward or reverse after pushing in the fast idle button to increase the idle speed.

It is necessary to position the control lever in the N (neutral) position to push in the fast idle button.

Return the control lever to N (neutral) position to cancel the fast idle operation.

CONTROLS AND FEATURES

Top-Mount Type

Ignition Switch

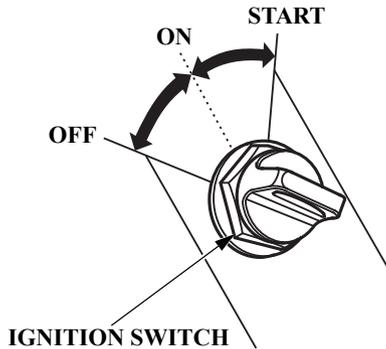

The ignition switch controls the ignition system and the starter motor.

Turning the ignition switch key to the START position operates the starter motor. The key automatically returns to the ON position when released from the START position.

The engine will not start unless the gearshift/throttle control lever is in the N (neutral) position (p. 47) and the emergency stop switch clip is in the emergency stop switch.

Turning the ignition switch to the OFF position stops the engine.

Emergency Stop Switch Clip and Emergency Stop Switch

EMERGENCY STOP SWITCH

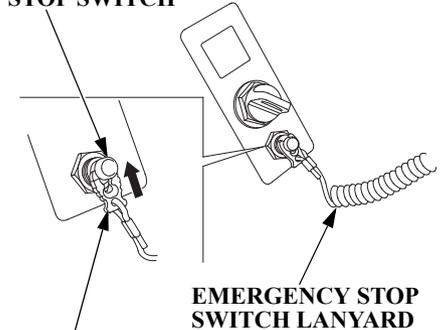

EMERGENCY STOP SWITCH CLIP

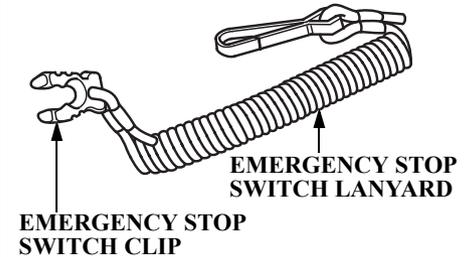

The emergency stop switch clip must be inserted in the emergency stop switch in order for the engine to start and run. The emergency stop switch lanyard must be attached securely to the operator or to the operator's PFD (Personal Flotation Device).

When used as described, the emergency stop switch clip and emergency stop switch lanyard system stops the engine if the operator falls away from the controls.

A spare switch clip (optional equipment) can be stored in the tool bag.

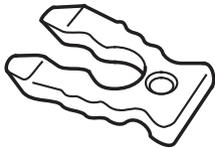

SPARE SWITCH CLIP
(optional equipment)

Gearshift/Throttle Control Lever

SINGLE TYPE

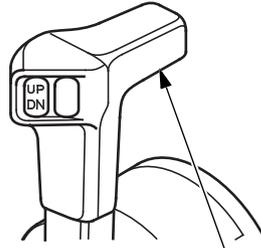

**GEARSHIFT/THROTTLE
CONTROL LEVER**

DUAL TYPE

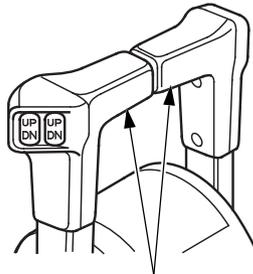

**GEARSHIFT/THROTTLE
CONTROL LEVERS**

The gearshift/throttle control lever(s) controls engine speed and selects F (forward), N (neutral), or R (reverse) gears.

CONTROLS AND FEATURES

Moving the control lever 35° from N (neutral) selects the gear, and further movement increases engine speed.

A friction adjuster inside the control box adjusts the operating resistance of the control lever(s). Refer to p. 52.

Less friction allows easier control lever movement. More friction helps to hold a steady throttle setting while cruising.

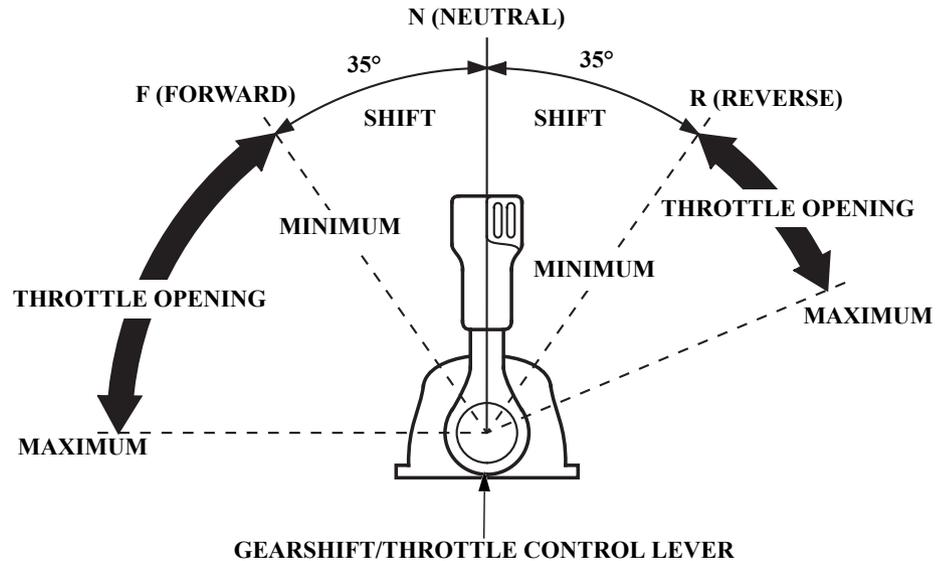

Fast Idle Button

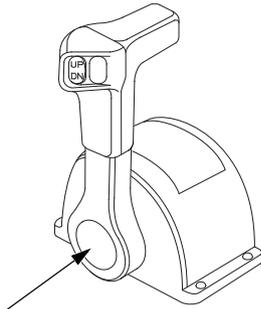

FAST IDLE BUTTON

Use the fast idle button to accelerate engine warm-up after starting the engine. Do not use the fast idle button when starting the engine.

See page 48 for engine warm-up instructions.

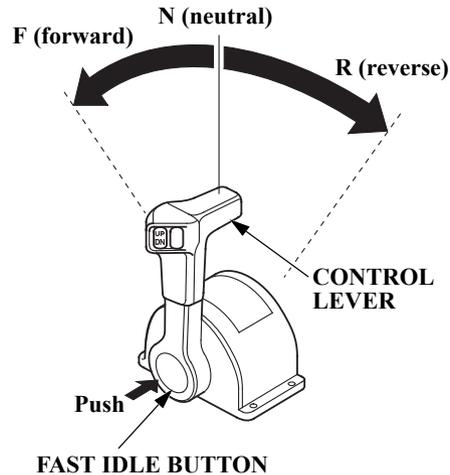

The fast idle button allows you to increase the idle speed without engaging the drive gears. Move the control lever forward or reverse after pushing in the fast idle button to increase the idle speed.

It is necessary to position the control lever in the N (neutral) position to push in the fast idle button.

Return the control lever to N (neutral) position to cancel the fast idle operation.

CONTROLS AND FEATURES

Common Controls

Power Trim/Tilt Switch

(Side-Mount Type)

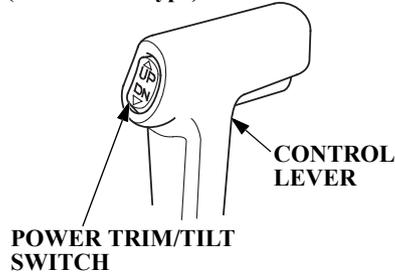

(Panel-Mount Type)

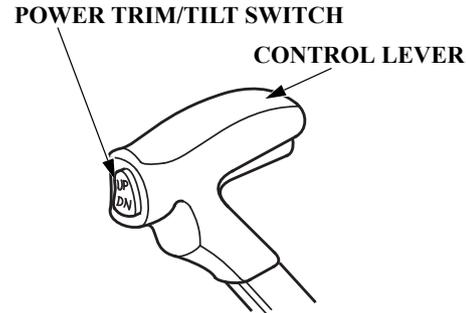

(Top-Mount Type)

SINGLE TYPE

POWER TRIM/TILT SWITCH

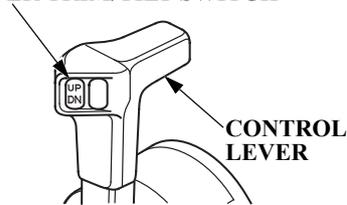

DUAL TYPE

POWER TRIM/TILT SWITCH

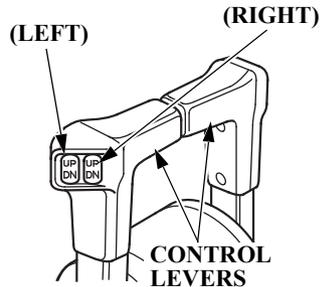

The power trim/tilt switch is located on the control lever. It is a rocker switch with UP and DN (down) positions for changing the angle of the outboard motor.

You can use the power trim/tilt switch anytime whether the boat is underway, stopped, or the ignition switch is in the OFF position. It is necessary for the ignition switch to be in the ON position for the trim meter to indicate the outboard motor angle.

Trim the outboard motor to obtain the best performance and stability (p. 53).

Tilt the outboard motor for shallow water operation, beaching, launching, or mooring.

For dual mount outboard motors, tilt them up at the same time.

Power Tilt Switch

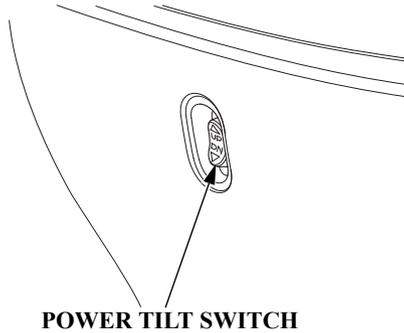

The power tilt switch is located on the engine pan. It is a rocker switch with UP and DN (down) positions for changing the angle of the outboard motor.

The power tilt switch will operate without turning the ignition switch ON.

This switch is used with the engine stopped to raise the outboard motor for mooring, trailering, or maintenance.

Manual Relief Valve

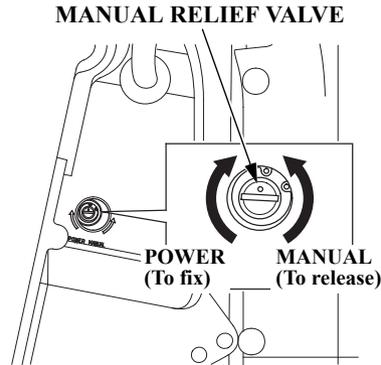

The outboard motor can be tilted manually after opening the manual relief valve. This allows the outboard motor to be tilted up or down when no battery is connected.

Check that nobody is under the outboard motor before opening the manual relief valve. If the manual relief valve is loosened (turned counterclockwise) when the outboard motor is tilted up, the outboard motor will suddenly tilt down.

Tilt Lock Lever

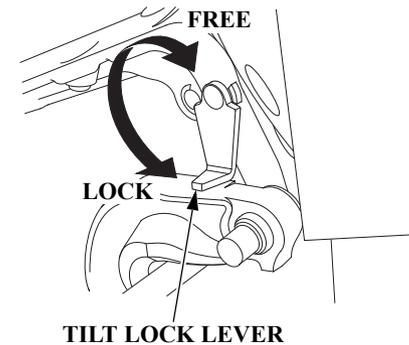

The tilt lock lever is used to support the outboard motor in the fully-raised position.

When the boat is to be moored for a long time, tilt the outboard motor up as far as it will go. Then move the tilt lock lever to the LOCK position, and gently lower the outboard motor until the lever contacts the stern bracket.

CONTROLS AND FEATURES

TRL (Trolling) Control Switch
(optional equipment; based on
control box)

Remote Control Box
(Side-Mount Type)

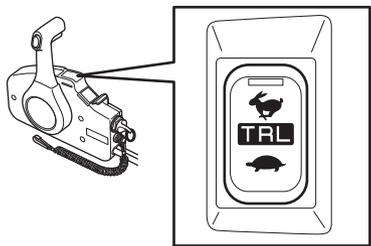

**TRL (Trolling)
CONTROL SWITCH**

Trolling Control Switch Panel
(optional equipment)

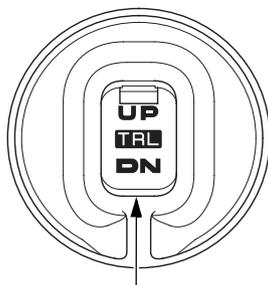

TRL (Trolling) CONTROL SWITCH

The TRL (Trolling) control switch is a rocker switch with UP and DN (down) positions to adjust the trolling speed up or down in 50 rpm increments within the range of 650 to 900 rpm.

If you press and hold the TRL control switch while cruising with the throttle closed, the mode changes to trolling mode (p. 55).

Engine Cover Latch

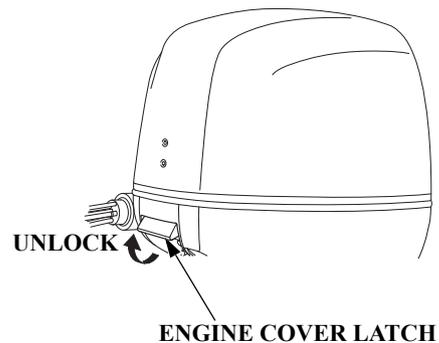

The engine cover latch fastens the engine cover to the outboard motor.

Trim Tab

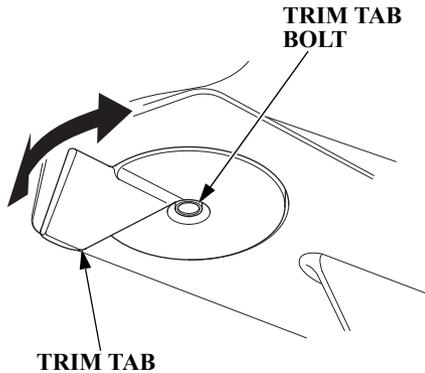

The trim tab compensates for “torque steer,” which is a reaction of the outboard motor to propeller rotation.

If uncompensated, torque steer would make the outboard motor tend to turn to one side.

When the trim tab is correctly adjusted (p. 64), steering effort is equal in both directions.

INSTRUMENTS

Trim Meter (optional equipment)

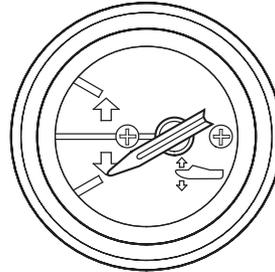

The trim meter indicates the relative trim angle of the outboard motor.

Refer to the trim meter when using the power trim/tilt switch to achieve the best performance from the boat.

Tachometer (optional equipment)

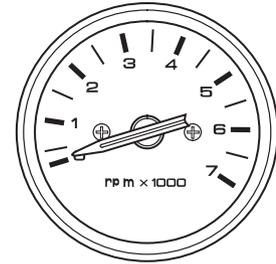

The tachometer shows engine speed in revolutions per minute.

Refer to the tachometer when using the throttle and power trim/tilt controls to achieve the best performance from the boat.

CONTROLS AND FEATURES

NMEA Interface Coupler

The NMEA2000® interface coupler can provide information regarding engine speed, fuel consumption, and various warnings to an existing NMEA2000 network via an optional interface cable. Contact your dealer for more information.

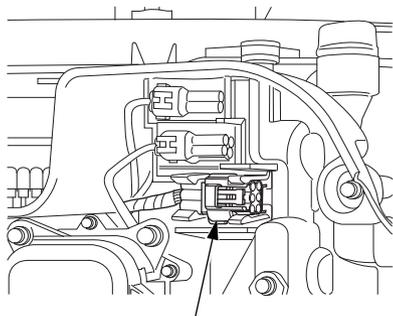

NMEA INTERFACE COUPLER

Operating Hour Notification System

This outboard motor engine counts the number of operating hours since the last periodic maintenance. When the next periodic maintenance is due, the engine notifies the NMEA2000 network, and a maintenance indication is displayed on an NMEA2000-compatible device.

After periodic maintenance is performed, reset the hour counter by:

1. Stopping the engine.
2. Setting the gearshift at F or R.
3. Turning the ignition switch ON.
The buzzer will sound once.
4. Pressing the emergency stop switch 5 times within 20 seconds.
The buzzer will sound once when the hour counter is reset.

Periodic maintenance is required when either the operating hours or the time since last maintenance reaches the prescribed limit. Therefore, periodic maintenance may be required based on the number of months since the last maintenance before the alert based on engine operating hours displays (see *MAINTENANCE SCHEDULE* on page 62).

Reset the hour counter whenever maintenance is performed, whether based on the time interval or the number of operating hours.

<Operating hour notification timing>

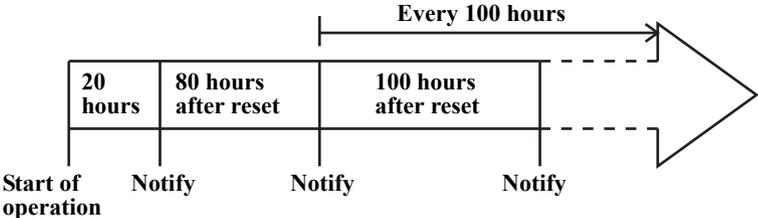

NMEA2000-compatible display:

- Follow instructions for the display.
- If the display allows selection of notification to be preset, select “Notify” (or equivalent).
- Turn on the power supply to the display before turning on the ignition switch of the outboard motor.
- The indication may differ, depending on the type of display.

<Display>

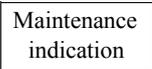
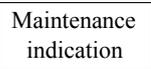
| Steps | 1 | 2 | 3 | 4 |
|-----------------------------------|---|---|---|--|
| Outboard motor | — | Ignition switch ON | Start engine | Gear at F or R |
| Display | Switch ON | — | — | — |
| Maintenance indication on display | Not shown Maintenance indication  | Shown Maintenance indication  | Shown Maintenance indication  | Not shown Maintenance indication  |

CONTROLS AND FEATURES

When "Periodic Maintenance" is indicated:

1. Have the periodic maintenance performed without delay after returning to port.
2. Reset the hour counter.
If not reset, the maintenance indication will remain in the display, and the hour count until the next maintenance will be in error.

When the periodic maintenance is conducted before "Periodic Maintenance" is indicated, reset the hour counter.

If not reset, the hour count until the next maintenance will be in error.

INDICATORS

The indicator lights come on and the buzzer sounds when you turn the ignition switch ON, allowing you to see that they are working. If an indicator does not light during this test, it cannot alert you if that system develops a problem. Have your TOHATSU dealer check for burned-out bulbs or other problems. Under normal conditions, the following occur when the ignition switch is turned ON:

1. The ACG, Malfunction, Oil Pressure, and Overheat indicators light.
2. The buzzer will beep twice.
3. The Malfunction, Oil Pressure, and Overheat indicators will go out after the second beep.
4. The ACG indicator will go out after the engine starts.
5. The Oil Pressure indicator will light again after the engine starts and will stay lit to indicate the oil pressure is normal.

Alternator (ACG) Indicator

(side-mount type)

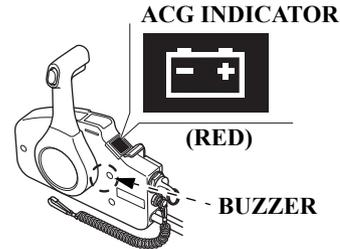

(panel-mount/top-mount types)

ACG INDICATOR

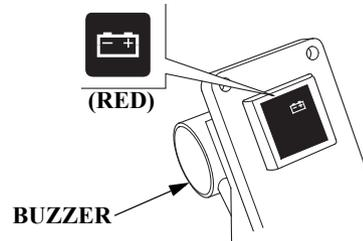

The ACG indicator turns on and the buzzer sounds in one-second intervals when the charging system is faulty.

Malfunction Indicator

(side-mount type)

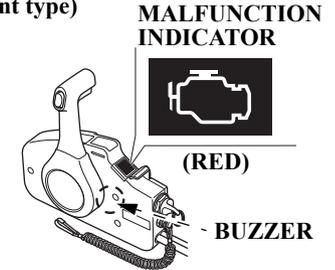

(panel-mount/top-mount types)

MALFUNCTION INDICATOR

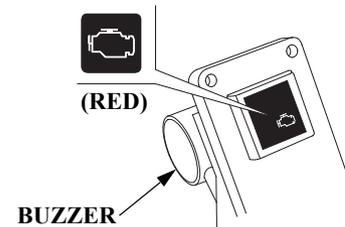

When the engine control system detects an engine control system malfunction, the malfunction indicator turns on and the buzzer sounds at one-second intervals.

CONTROLS AND FEATURES

Oil Pressure Indicator

(side-mount type)

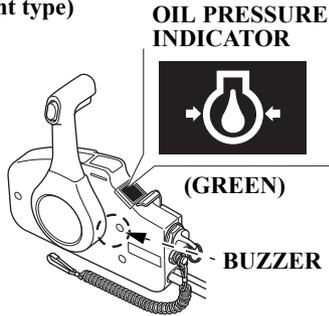

(panel-mount/top-mount types)

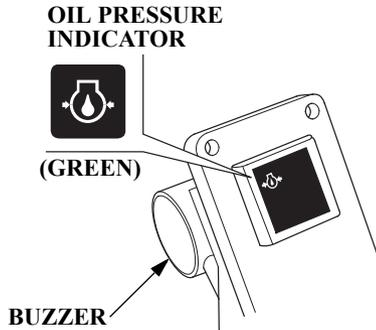

When the oil pressure indicator is lit, oil pressure is OK.

If oil pressure becomes low, the indicator will turn off, and the engine protection system will limit engine speed. Refer to *TAKING CARE OF UNEXPECTED PROBLEMS*, on p. 100.

All models are equipped with a buzzer that sounds continuously when the oil pressure indicator turns off.

Low oil pressure indicates that the engine oil level is low or that there is a problem with the engine lubrication system.

Overheat Indicator

(side-mount type)

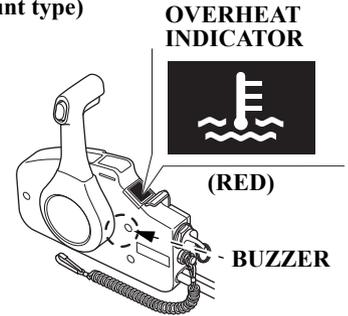

(panel-mount/top-mount types)

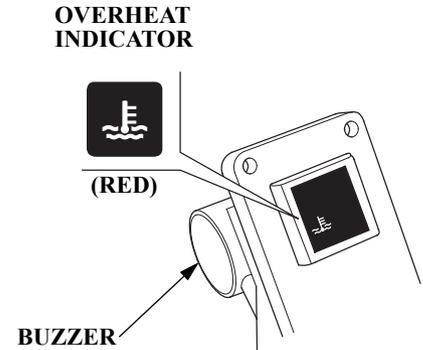

When the alert triggers, the overheat indicator comes on and the buzzer sounds a steady tone as the engine speed is reduced to 1,800 rpm. If the condition persists for another 20 seconds, the engine shuts off. Refer to *TAKING CARE OF UNEXPECTED PROBLEMS*, on p. 101.

All models are equipped with a buzzer that sounds continuously when the red overheat indicator light comes on.

Engine overheating may be the result of clogged water intakes.

Cooling System Indicator

COOLING SYSTEM INDICATOR

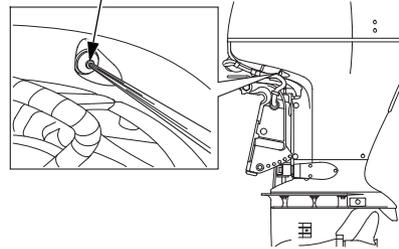

Water should flow from the cooling system indicator while the engine is running. This shows that water is circulating through the cooling system.

If water stops flowing while the engine is running, it indicates a cooling system problem, such as clogged water intakes, which will cause engine overheating.

The cooling system indicator discharge port can also become plugged.

OTHER FEATURES

Water Separator Buzzer

The water separator buzzer sounds a rapid, repeating signal when water has accumulated in the water separator.

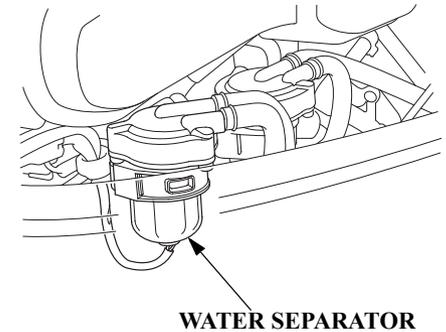

CONTROLS AND FEATURES

Rev Limiter

The engine is equipped with a rev limiter to prevent the possibility of mechanical damage from excessive engine speed.

The rev limiter may be activated during operation, limiting engine speed, if the outboard motor is trimmed or tilted up excessively, or when propeller ventilation occurs during a sharp turn.

If the rev limiter is activated, check the trim angle of the outboard motor.

Check to see if the correct propeller is installed.

Anodes

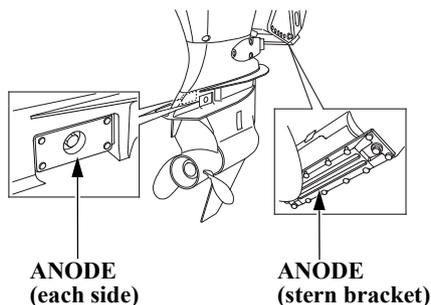

The anodes are made of a sacrificial material that helps to protect the outboard motor from corrosion.

There are two anodes on the gear case, one on the stern bracket and two small anodes in the water passages of the engine block.

Fuel Priming Bulb

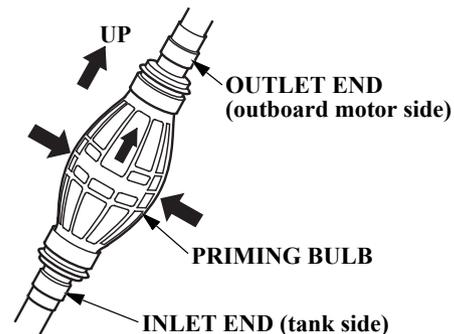

A priming bulb is built into the fuel hose that connects the fuel tank to the outboard motor.

Before starting the engine, hold the priming bulb up in the direction of the arrow; then squeeze the priming bulb until it feels firm. This will ensure that fuel is supplied to the engine (p. 40).

ARE YOU READY TO GET UNDERWAY?

Your safety is your responsibility. A little time spent in preparation will significantly reduce your risk of injury.

Knowledge

Read and understand this manual. Know what the controls do and how to operate them.

Familiarize yourself with the outboard motor and its operation before you get underway. Know what to do in case of an emergency.

Familiarize yourself with all laws and regulations relating to boating and the use of outboard motors.

Safety

Always wear a PFD (Personal Flotation Device) while on the boat.

Attach the emergency stop switch lanyard securely to the operator or to the operator's PFD.

IS YOUR OUTBOARD MOTOR READY TO GO?

For your safety, and to maximize the service life of your equipment, it is very important to take a few moments before you operate the outboard motor to check its condition. Be sure to take care of any problem you find, or have your authorized TOHATSU dealer correct it, before you operate the outboard motor.

BEFORE OPERATION

⚠ WARNING

Improperly maintaining this outboard motor or failing to correct a problem before operation can cause a malfunction in which you could be seriously hurt or killed.

Always perform a pre-operation inspection before each operation, and correct any problem.

Before beginning your pre-operation checks, be sure the ignition switch is in the OFF position.

BEFORE OPERATION

Safety Inspection

- Before each use, look around and underneath the engine for signs of oil or gasoline leaks.
- Check that the fuel hose is undamaged and properly connected.
- Wipe up any spills before starting the engine.
- Check the stern bracket to be sure the outboard motor is securely installed.
- Check that all controls are operating properly.
- Replace any damaged parts.
- Check that all fasteners are in place and securely tightened.
- Check the emergency stop switch for proper operation. Start the engine (p. 41, 44 or 46). Make sure

the engine stops by pulling the emergency stop switch clip from the emergency stop switch.

Maintenance Inspection

- Check the engine oil level (p. 66). Running the engine with a low oil level can cause engine damage. Overfilling the engine can cause the engine to smoke or have oil leaks which can cause engine damage.
- Check to be sure the propeller is undamaged and the castle nut is secured with the cotter pin (p. 84).
- Check that the anodes are securely attached to the stern bracket and the gear case (p. 83) and are not excessively worn. The anodes help protect the outboard motor from corrosion.
- Make sure the tool kit is onboard (p. 61). Replace any missing items.

- Check the fuel level in the fuel tank (p. 77).
- Check that the battery fluid is between the upper and lower levels, and the battery leads are connected securely.
- Check the water separator for water contamination (p. 81).

SAFE OPERATING PRECAUTIONS

To safely realize the full potential of this outboard motor, you need a complete understanding of its operation and a certain amount of practice with its controls.

Before operating the outboard motor for the first time, please review the *IMPORTANT SAFETY INFORMATION* on page 7 and the chapter titled *BEFORE OPERATION*.

For your safety, do not start or run the engine in a confined or partly enclosed area. Your engine's exhaust contains poisonous carbon monoxide, a colorless, odorless gas that can collect rapidly. Breathing carbon monoxide can cause loss of consciousness and may lead to death.

BREAK-IN PROCEDURE

Break-in period: 10 hours

Proper break-in operation allows the moving parts to wear in smoothly for best performance and long service life. Avoid continuous operation at a steady speed.

First 15 minutes:

Run the engine at trolling speed. Use the minimum throttle opening necessary to operate the boat at a safe trolling speed.

Next 45 minutes:

Run the engine up to a maximum of 2,000 to 3,000 rpm, which is about 10% to 30% of maximum throttle opening. Operating at maximum 2,000 ~ 3,000 rpm should be limited to 50% of the 45 minutes.

Next 60 minutes:

Run the engine up to a maximum of 4,000 to 5,000 rpm, which is about 50% to 80% of maximum throttle opening. Operating at maximum 4,000 ~ 5,000 rpm should be limited to 50% of the 60 minutes.

30-second full-throttle bursts are OK, but do not operate the engine continuously at full throttle.

For boats that plane easily, bring the boat up on plane, and then reduce the throttle opening to the recommended rpm range.

Next 8 hours:

Do not run the engine at full throttle for more than 5 minutes at a time.

OPERATION

FUEL PRIMING

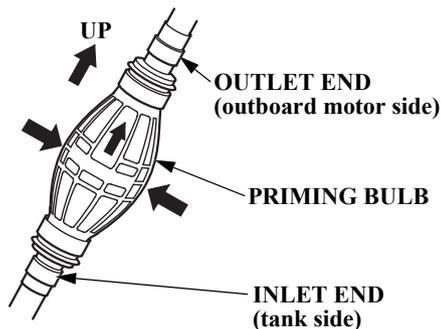

Hold the priming bulb up in the direction of the arrow; then squeeze the priming bulb several times until it feels firm, indicating that fuel has reached the engine.

Check to be sure there are no fuel leaks before starting the engine.

Do not touch the priming bulb with the engine running or when tilting up the outboard motor. The vapor separator could overflow.

⚠ WARNING

Gasoline is highly flammable and explosive, and you can be burned or seriously injured when handling fuel.

- Stop the engine and let it cool before handling fuel.
- Keep heat, sparks, and flame away.
- Handle fuel only outdoors.
- Wipe up spills immediately.

INFREQUENT OR OCCASIONAL USE

If your outboard motor will be used on an infrequent or intermittent basis, please refer to the fuel section of the *STORAGE* chapter (p. 87) for additional information regarding fuel deterioration.

STARTING THE ENGINE

Control

Side-Mount Type p. 41

Panel-Mount Type p. 44

Top-Mount Type p. 46

Side-Mount Type

EMERGENCY STOP SWITCH

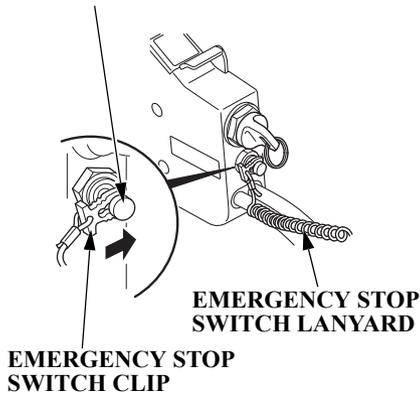

1. Put the emergency stop switch clip in the emergency stop switch, and attach the emergency stop switch lanyard securely to the operator or

to the operator's PFD (Personal Flotation Device).

The engine will not start or run, unless the emergency stop switch clip is in the emergency stop switch.

The emergency stop switch clip and emergency stop switch lanyard system is a safety device that will stop the engine if you fall away from the controls while operating the boat.

Always attach the emergency stop switch lanyard securely to the operator or to the operator's PFD before starting the engine.

Before leaving the dock, check the operation of the emergency stop switch.

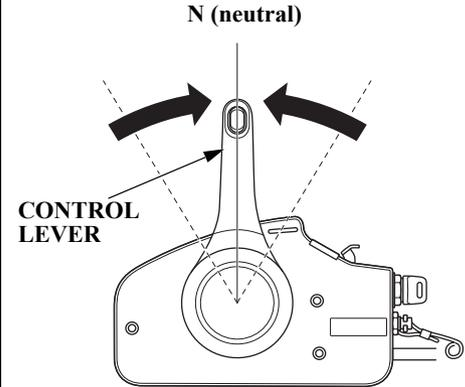

2. Set the control lever in the N (neutral) position.

The engine will not start if the F (forward) or R (reverse) gears are engaged.

OPERATION

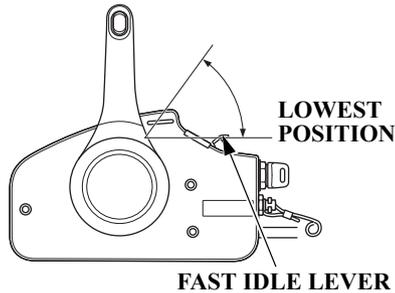

3. Leave the fast idle lever in the OFF (fully lowered) position.

The fast idle lever cannot be raised unless the control lever is in the N (neutral) position.

The control lever cannot be moved away from the N (neutral) position unless the fast idle lever is lowered.

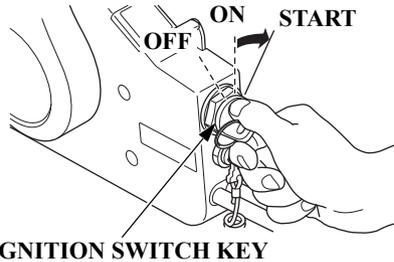

4. Turn the ignition switch key to the ON position; the buzzer will sound twice.
5. Turn the ignition switch key to the START position and hold it there until the engine starts. When the engine starts, release the key, allowing it to return to the ON position.

If the engine fails to start within 5 seconds, release the key and wait at least 10 seconds before operating the starter again.

NOTICE

- Using the electric starter for more than 5 seconds at a time will overheat the starter motor and can damage it.
- Turning the ignition switch key to the START position while the engine is running can damage the starter motor and flywheel.

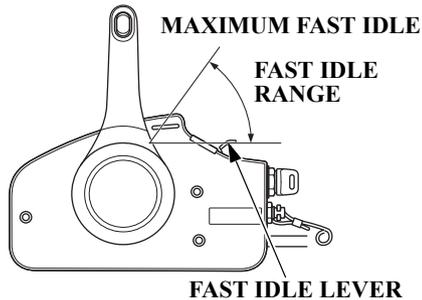

6. Before getting underway, allow the engine to warm-up sufficiently to ensure good performance.

Above 41°F (5°C), warm-up the engine for at least 3 minutes.

Below 41°F (5°C), warm-up the engine for at least 5 minutes at 2,000 rpm. Raise the fast idle lever to achieve approximately 2,000 rpm.

NOTICE

- *If the engine is not properly warmed up before raising the engine speed, the buzzer and overheat indicator may activate and the engine speed will be automatically reduced.*
- *The cooling system may freeze in areas where the temperature reaches 32°F (0°C) or below. Cruising at high speed without warming the engine up may cause engine damage.*

During the warm-up period, check the oil pressure indicator (p. 34), overheat indicator (p. 34), and cooling system indicator (p. 35).

If the indicators show any abnormal condition, immediately stop the engine and determine the cause of the problem. Refer to *TAKING CARE OF UNEXPECTED PROBLEMS* on p. 100 – 103.

7. If the fast idle lever was used to warm-up the engine, gradually lower the lever as the engine warms up.

When the fast idle lever is fully lowered, the control lever can be moved away from the N (neutral) position.

OPERATION

Panel-Mount Type

EMERGENCY STOP SWITCH

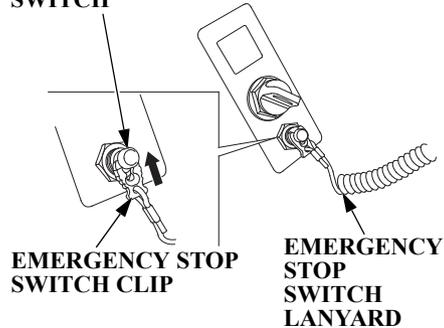

1. Put the emergency stop switch clip in the emergency stop switch, and attach the emergency stop switch lanyard securely to the operator or to the operator's PFD (Personal Flotation Device).

The engine will not start or run, unless the emergency stop switch clip is in the emergency stop switch.

The emergency stop switch clip and emergency stop switch lanyard system is a safety device that will stop the engine if you fall away from the controls while operating the boat.

Always attach the emergency stop switch lanyard securely to the operator or to the operator's PFD before starting the engine.

Before leaving the dock, check the operation of the emergency stop switch.

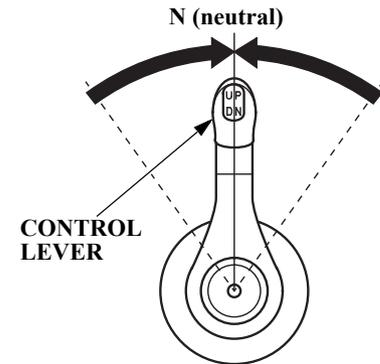

2. Set the control lever in the N (neutral) position.

The engine will not start if the F (forward) or R (reverse) gears are engaged.

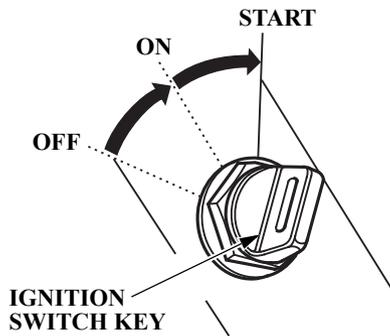

3. Turn the ignition switch key to the ON position; the buzzer will sound twice.
4. Turn the ignition switch key to the START position and hold it there until the engine starts. When the engine starts, release the key, allowing it to return to the ON position.

If the engine fails to start within 5 seconds, release the key and wait at least 10 seconds before operating the starter again.

NOTICE

- *Using the electric starter for more than 5 seconds at a time will overheat the starter motor and can damage it.*
- *Turning the ignition switch key to the START position while the engine is running can damage the starter motor and flywheel.*

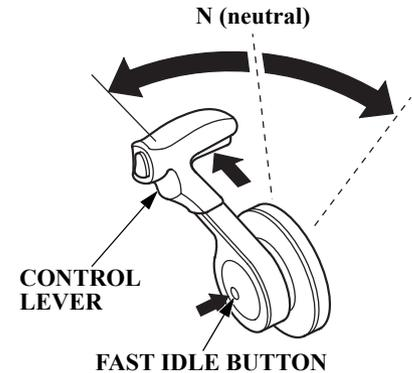

5. Before getting underway, allow the engine to warm-up sufficiently to ensure good performance.

Above 41°F (5°C), warm-up the engine for at least 3 minutes.

Below 41°F (5°C), warm-up the engine for at least 5 minutes at 2,000 rpm. Push the fast idle button, and then move the control lever forward or reverse to open the throttle and achieve approximately 2,000 rpm.

OPERATION

NOTICE

- *If the engine is not properly warmed up before raising the engine speed, the buzzer and overheat indicator may activate and the engine speed will be automatically reduced.*
- *The cooling system may freeze in areas where the temperature reaches 32°F (0°C) or below. Cruising at high speed without warming the engine up may cause engine damage.*

During the warm-up period, check the oil pressure indicator (p. 34), overheat indicator (p. 34), and cooling system indicator (p. 35).

If the indicators show any abnormal condition, immediately stop the engine and determine the cause of the problem. Refer to *TAKING CARE OF UNEXPECTED PROBLEMS* on p. 100 – 103.

6. If the fast idle control was used to warm-up the engine, gradually return the control lever to the N (neutral) position as the engine warms up.

Top-Mount Type

EMERGENCY STOP SWITCH

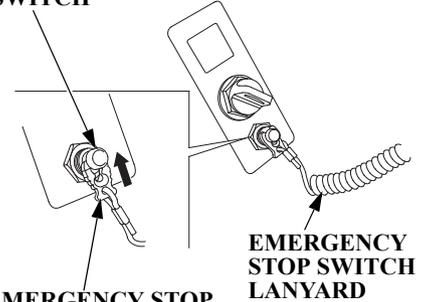

EMERGENCY STOP SWITCH CLIP

1. Put the emergency stop switch clip in the emergency stop switch, and attach the emergency stop switch lanyard securely to the operator or to the operator's PFD (Personal Flotation Device).

The engine will not start or run, unless the emergency stop switch clip is in the emergency stop switch.

The emergency stop switch clip and emergency stop switch lanyard system is a safety device that will stop the engine if you fall away from the controls while operating the boat.

Always attach the emergency stop switch lanyard securely to the operator or to the operator's PFD before starting the engine.

Before leaving the dock, check the operation of the emergency stop switch.

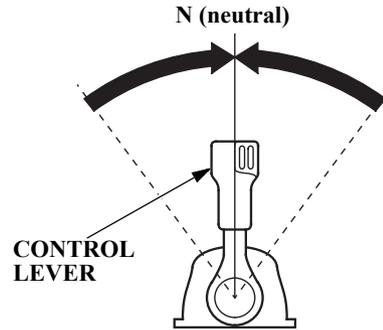

2. Set the control lever in the N (neutral) position.

The engine will not start if the F (forward) or R (reverse) gears are engaged.

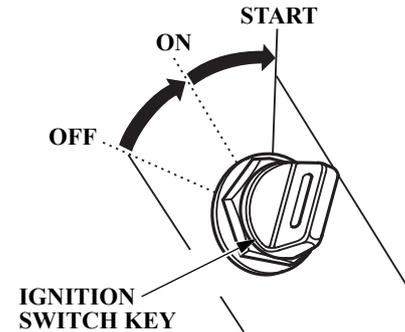

3. Turn the ignition switch key to the ON position; the buzzer will sound twice.
4. Turn the ignition switch key to the START position and hold it there until the engine starts. When the engine starts, release the key, allowing it to return to the ON position.

OPERATION

If the engine fails to start within 5 seconds, release the key and wait at least 10 seconds before operating the starter again.

NOTICE

- Using the electric starter for more than 5 seconds at a time will overheat the starter motor and can damage it.
- Turning the ignition switch key to the START position while the engine is running can damage the starter motor and flywheel.

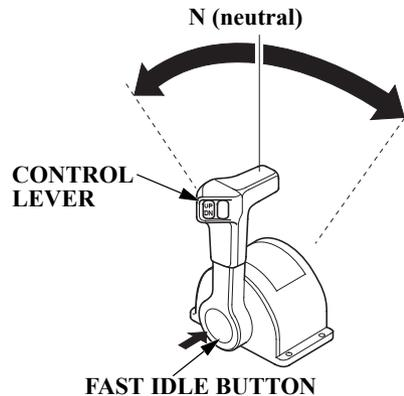

5. Before getting underway, allow the engine to warm-up sufficiently to ensure good performance.

Above 41°F (5°C), warm-up the engine for at least 3 minutes.

Below 41°F (5°C), warm-up the engine for at least 5 minutes at 2,000 rpm. Push the fast idle button, and then move the control lever forward or reverse to open the throttle and achieve approximately 2,000 rpm.

NOTICE

- If the engine is not properly warmed up before raising the engine speed, the buzzer and overheat indicator may activate and the engine speed will be automatically reduced.
- The cooling system may freeze in areas where the temperature reaches 32°F (0°C) or below. Cruising at high speed without warming the engine up may cause engine damage.

During the warm-up period, check the oil pressure indicator (p. 34), overheat indicator (p. 34), and cooling system indicator (p. 35).

If the indicators show any abnormal condition, immediately stop the engine and determine the cause of the problem. Refer to *TAKING CARE OF UNEXPECTED PROBLEMS* on p. 100 – 103.

6. If the fast idle control was used to warm-up the engine, gradually return the control lever to the N (neutral) position as the engine warms up.

STOPPING THE ENGINE

Emergency Engine Stopping

Side-Mount Type

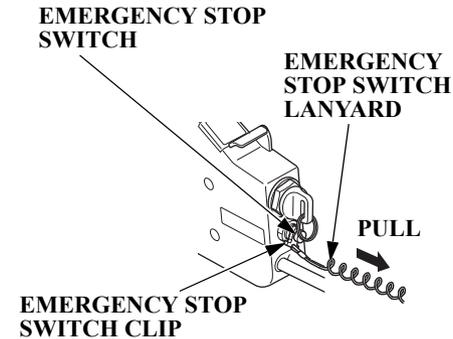

Panel-Mount/Top-Mount Types

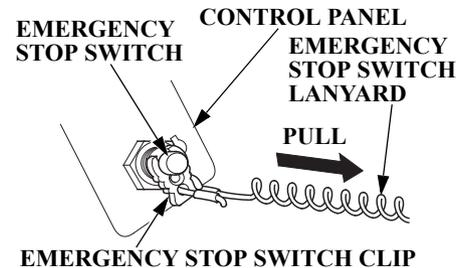

To stop the engine in an emergency, pull the emergency stop switch clip out of the emergency stop switch by pulling the emergency stop switch lanyard.

We suggest that you stop the engine this way occasionally to verify that the emergency stop switch is operating properly.

Before leaving the dock, check the operation of the emergency stop switch.

Turn the ignition switch key to the OFF position after verifying the emergency stop switch operation.

OPERATION

Normal Engine Stopping

Side-Mount Type

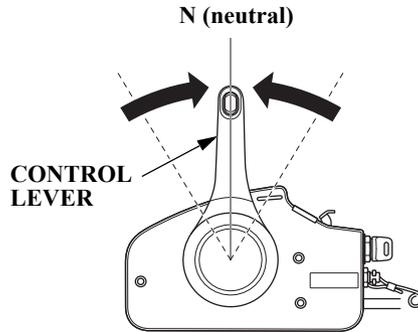

Panel-Mount Type

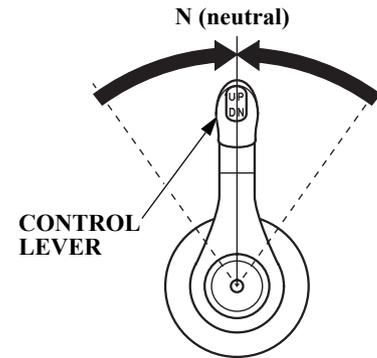

Top-Mount Type

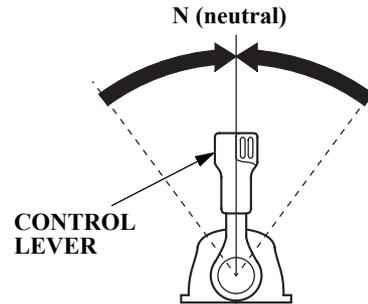

1. Move the control lever(s) to the N (neutral) position.

After cruising at full throttle, cool down the engine by idling for a few minutes before stopping the engine.

Side-Mount Type

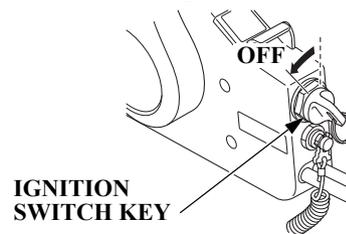

Panel-Mount/Top-Mount Types

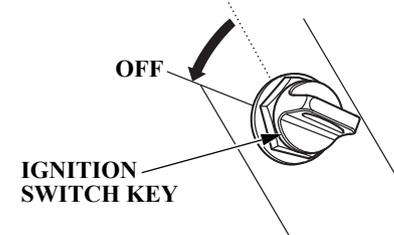

2. Turn the ignition switch key to the OFF position to stop the engine. In the event that the engine does not stop when the ignition switch key is turned to OFF, press the emergency stop switch until the engine stops.
3. When the boat is not in use, remove and store the ignition switch key and the emergency stop switch clip and lanyard.

GEARSHIFT AND THROTTLE OPERATION

Side-Mount Type

CONTROL LEVER

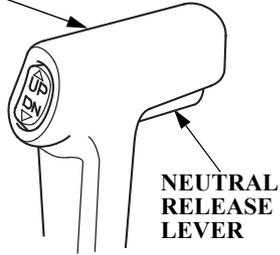

NEUTRAL
RELEASE
LEVER

N (neutral)

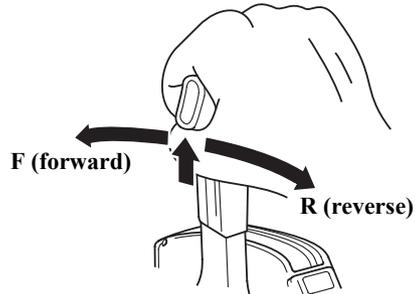

F (forward)

R (reverse)

Panel-Mount Type

F (forward) N (neutral) R (reverse)

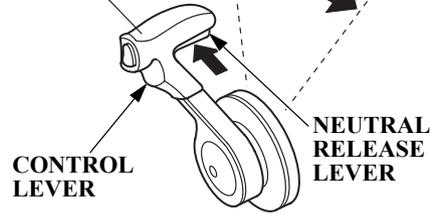

CONTROL
LEVER

NEUTRAL
RELEASE
LEVER

Top-Mount Type

F (forward) N (neutral) R (reverse)

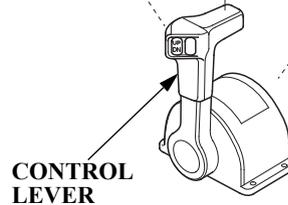

CONTROL
LEVER

To shift gears, move the control lever to select the F (forward), N (neutral), or R (reverse) gear.

The control lever cannot be moved from the N (neutral) position unless the neutral release lever is squeezed (side-mount/panel-mount types).

Moving the control lever beyond the gear selection range increases engine speed.

OPERATION

Side-Mount Type

**CONTROL LEVER
FRICTION
ADJUSTER**

**TO DECREASE
FRICTION**

**TO INCREASE
FRICTION**

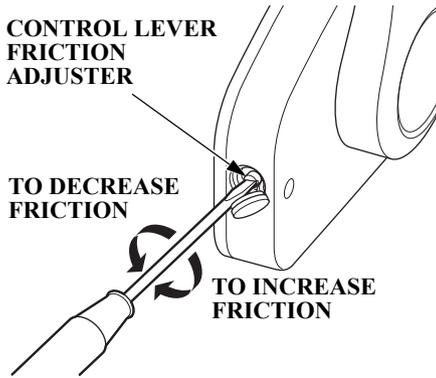

Panel-Mount Type

**CONTROL LEVER
FRICTION
ADJUSTER**

**TO INCREASE
FRICTION**

**TO DECREASE
FRICTION**



Top-Mount Type

**TO INCREASE
FRICTION**

**TO DECREASE
FRICTION**

**CONTROL LEVER
FRICTION
ADJUSTER**

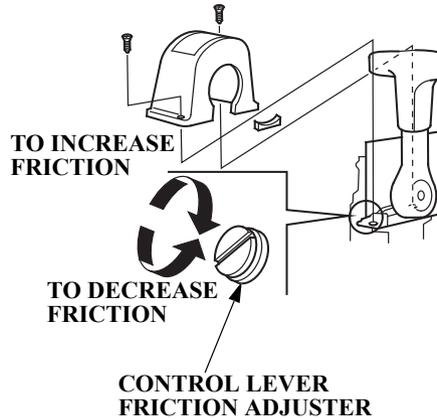

Adjust the control lever friction adjuster so the control lever will hold a constant throttle setting while cruising.

STEERING

Steer the boat in the same manner as an automobile.

CRUISING

Engine Speed

For best fuel economy, limit the throttle opening to 80%. Use the throttle friction control (p. 52) to help you hold a steady speed.

For rough water conditions or large waves, slow down to prevent the propeller from rising out of the water.

The engine is equipped with a rev limiter to prevent the possibility of mechanical damage from excessive engine speed.

If, for example, the outboard motor is tilted excessively or propeller ventilation occurs during a sharp turn, the engine may overrev, activating the rev limiter.

If engine speed becomes unstable at high speed due to activation of the rev limiter, reduce speed and check the trim angle of the outboard motor.

Trim

Use the power trim/tilt switch to trim the outboard motor for the best performance and stability.

You can use the power trim/tilt switch at any time, whether the boat is underway or stopped.

Press the UP or DN (down) side of the switch to adjust the angle of the outboard motor.

Refer to the trim meter (p. 29) for an indication of whether the outboard motor is trimmed high or low.

It is necessary to trim the angle of the outboard motor to compensate for changes in boat load, weight distribution, water conditions, or propeller selection.

Under normal conditions, the boat will perform best when the antiventilation plate is level with the water surface.

When cruising into a high wind, trim the outboard motor down slightly to level the boat and improve stability. With a tail wind, trim the outboard motor up slightly.

NOTICE

Excessive trim/tilt angle during operation can cause propeller ventilation, overheating, and water pump damage.

OPERATION

Side-Mount Type

POWER TRIM/TILT SWITCH

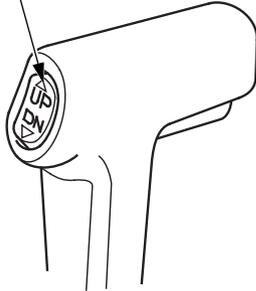

Panel-Mount Type

POWER TRIM/TILT SWITCH

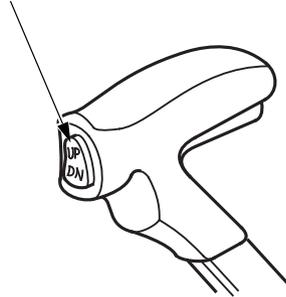

Top-Mount Type

(single type)

POWER TRIM/TILT SWITCH

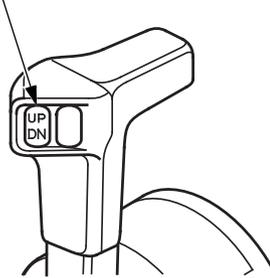

(dual type)

POWER TRIM/TILT SWITCH

(LEFT)

(RIGHT)

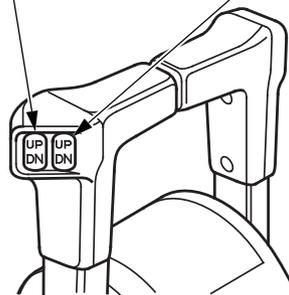

OUTBOARD MOTOR TRIMMED TOO LOW



OUTBOARD MOTOR TRIMMED TOO HIGH



OUTBOARD MOTOR TRIMMED CORRECTLY



BOW TOO LOW DUE TO

1. LOAD IN THE FRONT
2. OUTBOARD MOTOR TRIMMED TOO LOW

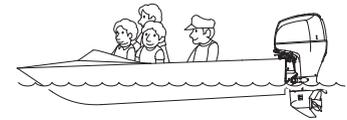

BOW TOO HIGH DUE TO

1. LOAD IN THE REAR
2. OUTBOARD MOTOR TRIMMED TOO HIGH

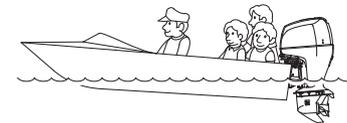

Trolling Speed Control

Remote Control Box (Side-Mount Type)

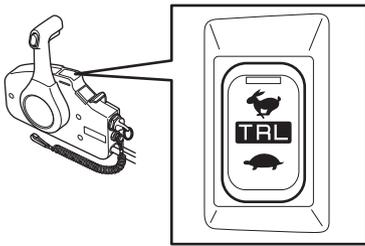

TRL (Trolling) CONTROL SWITCH

Trolling Control Switch Panel (optional equipment)

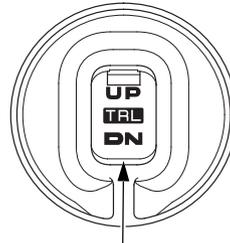

TRL (Trolling) CONTROL SWITCH

DN: Reduce engine speed
UP: Increase engine speed

The engine must be fully warmed up before you can activate the Trolling Speed Control. Place the outboard motor in-gear with the throttle control in the fully closed (idle) position. Press and hold the UP or DN side of the TRL control switch to activate the Trolling Speed Control. The buzzer will make one long sound indicating activation.

The initial trolling speed is set at 650 rpm.

The engine speed can be adjusted in 50 rpm increments by pressing the UP or DN side of the TRL control switch. A short sound of the buzzer occurs each time the engine speed is adjusted.

In Trolling Speed Control mode, the engine speed can be adjusted between 650 and 900 rpm.

Continuing to press the switch when at either of these limits will result in two short sounds from the buzzer.

The throttle control will operate when in the Trolling Speed Control mode, but once the speed reaches 3,000 rpm, the Trolling Speed Control is deactivated. If 3,000 rpm is not reached and the throttle is closed, the engine speed will decrease to the Trolling Speed Control setting.

OPERATION

TRIM TAB

If steering effort is not equal in both directions, adjust the trim tab to compensate for “torque steer,” which is the reaction of the outboard motor to propeller rotation.

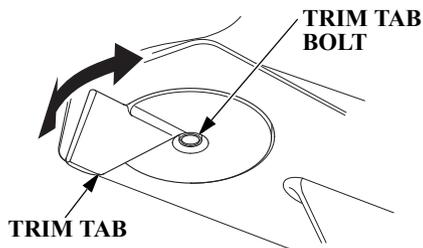

Adjust the trim tab with the engine stopped. Loosen the bolt above the trim tab, turn the trim tab, and then tighten the bolt securely.

When the trim tab is correctly adjusted, steering effort will be equal in both directions.

Refer to *TRIM TAB ADJUSTMENT* on p. 64.

SHALLOW WATER OPERATION

When operating in shallow water, use the power trim/tilt switch (p. 54) to tilt the outboard motor so that the propeller and gear case won't hit the bottom.

Proceed at low speed, and monitor water flow from the cooling system indicator (p. 35) to be sure the outboard motor is not tilted so high that the water intakes are out of the water.

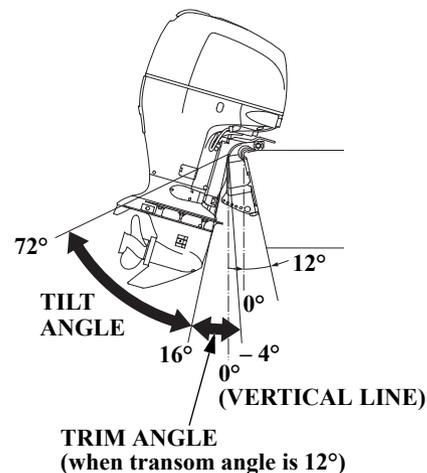

MOORING, BEACHING, LAUNCHING

Before tilting up, leave the outboard motor in the running position for one minute after stopping the engine to drain the water from inside the engine.

Stop the engine and disconnect the fuel hose from the outboard motor before tilting the outboard motor.

To raise the outboard motor out of the water while the engine is stopped and the boat is moored, or for maximum clearance when beaching or launching, use the power tilt switch on the engine pan to tilt the outboard motor up as far as it will go. Move the tilt lock lever to the LOCK position, and then gently lower the outboard motor until the lever contacts the stern bracket. Use the power tilt switch to fully shorten the trim rods.

TRIM RODS

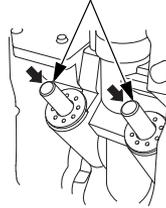

To lower the outboard motor, tilt up using the power tilt switch, then move the tilt lock lever to the FREE position, and then lower the outboard motor to the desired position.

NOTICE

Do not attempt to use the power tilt switch to tilt the outboard motor down while the tilt lock lever is in the LOCK position. Damage to the power tilt system may occur.

POWER TILT SWITCH

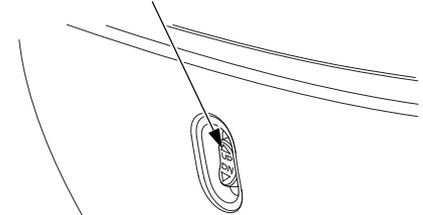

TILT LOCK LEVER
(Lock position)

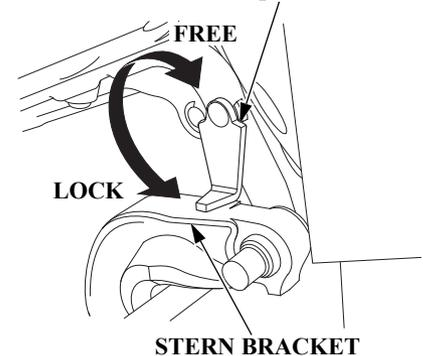

OPERATION

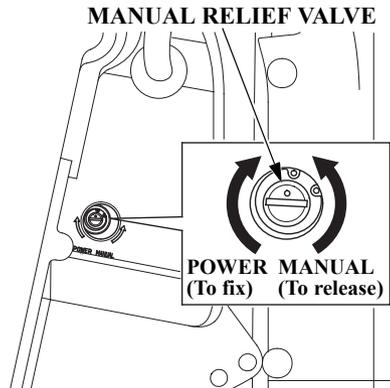

The outboard motor can also be tilted manually after opening the manual relief valve. This feature enables the outboard motor to be tilted up or down when no battery is connected.

For manual tilting, use a screwdriver to turn the valve counterclockwise 1 or 2 turns. Close the valve firmly after positioning the engine.

Be sure the valve is closed before operating the outboard motor. If the valve is not closed, the outboard motor will tilt up when operated in reverse.

Check that nobody is under the outboard motor before opening the manual relief valve. If the manual relief valve is loosened (turned counterclockwise) when the outboard motor is tilted up, the outboard motor will suddenly tilt down.

MULTIPLE OUTBOARD MOTORS

On boats equipped with more than one outboard motor, all motors normally operate at the same time.

If one or more motor(s) is stopped while the other(s) is running, put the stopped motor in “N” (neutral) and tilt it up so its propeller is above the water’s surface.

If the propeller of the stopped motor is left in the water, it may turn as the boat moves through the water, causing a reverse flow of water from the exhaust side. This reverse flow will happen if the stopped engine’s propeller is in the water, its gearshift is in “R” (reverse), and the boat is moving forward. Reverse flow can cause an engine malfunction.

SERVICING YOUR OUTBOARD MOTOR

THE IMPORTANCE OF MAINTENANCE

Proper maintenance is essential for safe, economical, and trouble-free operation. It will also help reduce air pollution.

WARNING

Improperly maintaining this outboard motor or failure to correct a problem before operation can cause a malfunction in which you could be seriously hurt or killed.

Always follow the inspection and maintenance recommendations and schedules in this Owner's Manual.

To help you properly care for your outboard motor, the following pages include a maintenance schedule, routine inspection procedures, and simple maintenance procedures using basic hand tools. Other service tasks that are more difficult or require special tools are best handled by professionals and are normally performed by a TOHATSU technician or other qualified mechanic.

The maintenance schedule applies to normal operating conditions. If you operate your outboard motor under unusual conditions, consult an authorized TOHATSU dealer for recommendations applicable to your individual needs and use.

Remember that your authorized TOHATSU dealer knows your outboard motor best and is fully equipped to maintain and repair it.

To ensure the best quality and reliability, use only new, TOHATSU Genuine parts or their equivalents for repair and replacement.

Maintenance, replacement, or repair of the emission control devices and systems may be performed by any marine engine repair establishment or individual, using parts that are “certified” to EPA standards.

SERVICING YOUR OUTBOARD MOTOR

MAINTENANCE SAFETY

Some of the most important safety precautions follow. However, we cannot warn you of every conceivable hazard that can arise in performing maintenance. Only you can decide whether or not you should perform a given task.

WARNING

Failure to properly follow maintenance instructions and precautions can cause you to be seriously hurt or killed.

Always follow the procedures and precautions in the Owner's Manual.

Safety Precautions

- Make sure the engine is off before you begin any maintenance or repairs. This will eliminate several potential hazards:
 - **Carbon monoxide poisoning from engine exhaust.**
Do not start or run the engine in a confined or partly enclosed area.
 - **Burns from hot parts.**
Let the engine and exhaust system cool before touching.
 - **Injury from moving parts.**
Do not run the engine unless instructed to do so.
- Read the instructions before you begin, and make sure you have the tools and skills required.
- To reduce the possibility of fire or explosion, be careful when working around gasoline. Use only a nonflammable solvent, not gasoline, to clean parts. Keep cigarettes, sparks, and flames away from all fuel-related parts.
- Wear gloves when handling the propeller to protect your hands from sharp edges.

SERVICING YOUR OUTBOARD MOTOR

TOOL KIT and OWNER'S MANUAL

(Tool kit does not come with Counter Rotation Types)

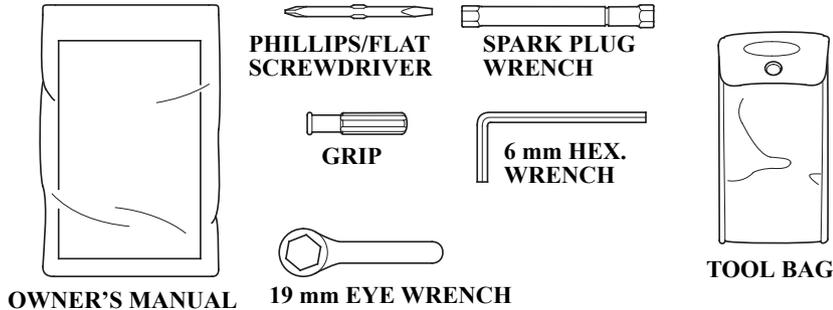

The tool kit can be used for simple maintenance procedures and emergency repairs. Keep these items on the boat so that they will always be available if you need them.

If your tool kit needs replacement, it is not available as a kit and each item must be ordered individually.

SPARE EMERGENCY STOP SWITCH CLIP

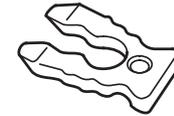

Always carry a spare emergency stop switch clip onboard. The spare clip may either be stored in the tool bag or in an easily accessible location on the boat.

SERVICING YOUR OUTBOARD MOTOR

MAINTENANCE SCHEDULE

Follow the MAINTENANCE SCHEDULE table and service your outboard motor accordingly.

| REGULAR SERVICE PERIOD (3) Perform at every indicated month or operating hour interval, whichever comes first. | | Each use | After use | First month or 20 hrs. | Every 6 months or 100 hrs. | Every year or 200 hrs. | Every 2 years or 400 hrs. | Refer to page |
|--|----------------------|----------|-----------|---------------------------------|-------------------------------------|---------------------------------|------------------------------------|------------------|
| ITEM | | | | | | | | |
| Engine oil | Check level | o | | | | | | 66 |
| | Change | | | o | o | | | |
| Engine oil filter | Replace | | | | | o (2) | | 69 |
| Gear case oil | Change | | | o (2) | o (2) | | | – |
| ACG belt | Check-adjust | | | | | o (2) | | – |
| Throttle linkage | Check-adjust | | | o (2) | o (2) | | | – |
| Idle speed | Check-adjust | | | o (2) | o (2) | | | – |
| Valve clearance | Check-adjust | | | | | o (2) | | – |
| Spark plug (Standard plug) | Check-adjust/Replace | | | | o | | | 73 – 75 |
| Propeller and cotter pin | Check | o | | | | | | 84 |
| Anode metal | Check Outside engine | o | | | | | | 83 |
| Anode metal | Check Inside engine | | | | | | o (2) (6) | – |
| Lubrication | Grease | | | o (1) | o (1) | | | 71 – 72 |
| Water separator | Check | o | | | | | | 81 – 82 |
| Fuel filter (Low pressure side) | Check | | | | o | | | 78 – 80 |
| | Replace | | | | | | o | |

(1) Lubricate more frequently when used in salt water.

(2) These items should be serviced by your servicing dealer, unless you have the proper tools and are mechanically proficient. Refer to the TOHATSU Service Manual for service procedures.

(3) For professional commercial use, log hours of operation to determine proper maintenance intervals.

(6) Replace the anodes when they have been reduced to about one third their original size, or if they are crumbling.

SERVICING YOUR OUTBOARD MOTOR

| REGULAR SERVICE PERIOD (3) Perform at every indicated month or operating hour interval, whichever comes first. | | Each use | After use | First month or 20 hrs. | Every 6 months or 100 hrs. | Every year or 200 hrs. | Every 2 years or 400 hrs. | Refer to page |
|--|-----------------------|----------|--------------------------------------|---------------------------------|-------------------------------------|---------------------------------|------------------------------------|------------------|
| ITEM | | | | | | | | |
| Fuel filter (High pressure side) | Replace | | | | | | o (2) | – |
| Thermostat | Check | | | | | o (2) | | – |
| Fuel line | Check | o (7) | | | | | | 38 |
| | Replace | | Every 2 years (If necessary) (2) (8) | | | | | |
| Battery and cable connection | Check level-tightness | o | | | | | | 38 |
| Bolts and nuts | Check-tightness | | | o (2) | o (2) | | | – |
| Crankcase breather tube | Check | | | | | o (2) | | – |
| Cooling water passages | Clean | | o (4) | | | | | – |
| Water pump | Check | | | | | o (2) | | – |
| Emergency stop switch | Check | o | | | | | | 38 |
| Engine oil leak | Check | o | | | | | | – |
| Each operation part | Check | o | | | | | | – |
| Engine condition (5) | Check | o | | | | | | – |
| Power Trim/Tilt | Check | | | | o (2) | | | – |
| Spark plug | Check | | | | | o | | 76 |
| (Optional iridium plug) | Replace | | | | | | o | 76 |
| Shift Cable | Check-adjust | | | | o (2) | | | – |

- (2) These items should be serviced by your servicing dealer, unless you have the proper tools and are mechanically proficient. Refer to the TOHATSU Service Manual for service procedures.
- (3) For professional commercial use, log hours of operation to determine proper maintenance intervals.
- (4) When operating in salt water, turbid or muddy water, the engine should be flushed with clean water after each use.
- (5) Upon starting, check for unusual engine sounds and cooling water flowing freely from the check hole.
- (7) Check the fuel line for leaks, cracks or damage. If it is leaking, cracked or damaged, take it to your servicing dealer for replacement before using your outboard.
- (8) Replace the fuel line if there are signs of leaks, cracks or damage.

SERVICING YOUR OUTBOARD MOTOR

TRIM TAB ADJUSTMENT

The trim tab compensates for “torque steer,” which is a reaction of the outboard motor to propeller rotation.

If uncompensated, torque steer would make the outboard motor tend to turn to one side.

When the trim tab is correctly adjusted, steering effort is equal in either direction.

If steering effort is unequal, loosen the trim tab bolt and adjust the angle of the trim tab. Retighten the trim tab bolt securely.

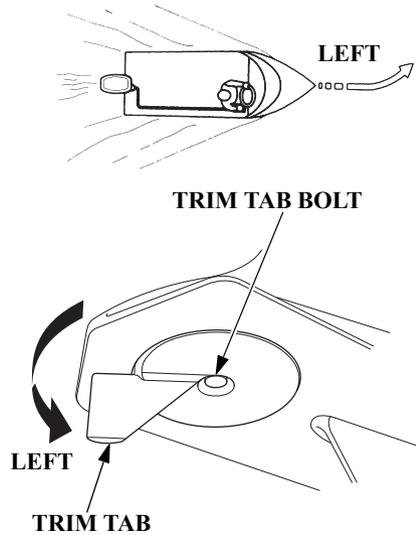

If less effort is required to make left turns, move the back of the trim tab left.

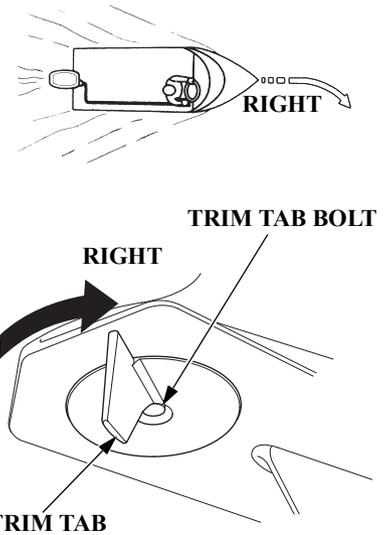

If less effort is required to make right turns, move the back of the trim tab right.

Adjust the trim tab in small increments, and retest steering effort with the boat evenly loaded and running at cruising speed.

SERVICING YOUR OUTBOARD MOTOR

MANUAL RELIEF VALVE

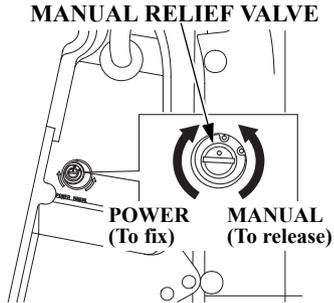

The outboard motor can be tilted manually after opening the manual relief valve. This feature enables the outboard motor to be tilted up or down when no battery is connected.

For manual tilting, use a screwdriver to turn the valve counterclockwise 1 or 2 turns. Close the valve firmly after positioning the outboard motor.

Be sure the valve is closed before operating the outboard motor. If the valve is not closed, the outboard motor will tilt up when operated in reverse.

Check that nobody is under the outboard motor before opening the manual relief valve. If the manual relief valve is loosened (turned counterclockwise) when the outboard motor is tilted up, the outboard motor will suddenly tilt down.

ENGINE COVER REMOVAL AND INSTALLATION

ENGINE COVER

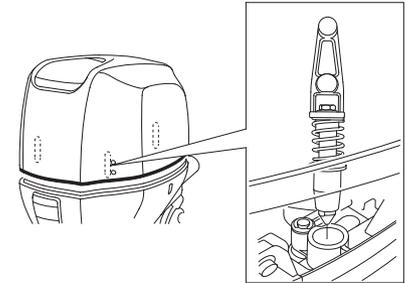
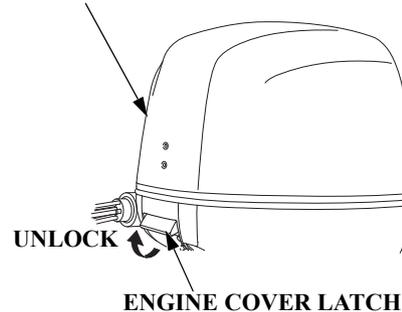

The engine cover latch fastens the engine cover to the outboard motor.

To remove the engine cover, pull the engine cover latch to the unlocked position, then lift the engine cover straight up from the outboard motor.

To install the engine cover, place the cover on the outboard motor, and push down evenly.

The cover should be tight at the mid-case point. If the cover is loose or difficult to secure, an adjustment may be necessary. Please see the service manual or your TOHATSU dealer for adjustment.

SERVICING YOUR OUTBOARD MOTOR

Engine Oil Level Check

Check the engine oil level with the engine stopped and the outboard motor in the vertical position.

1. Unlock and remove the engine cover (p. 65).
2. Remove the dipstick and wipe it clean.

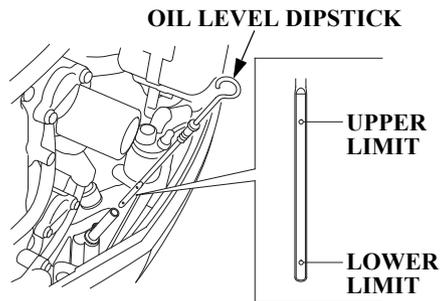

3. Insert the dipstick all the way in, then remove it and check the oil level shown on the dipstick.

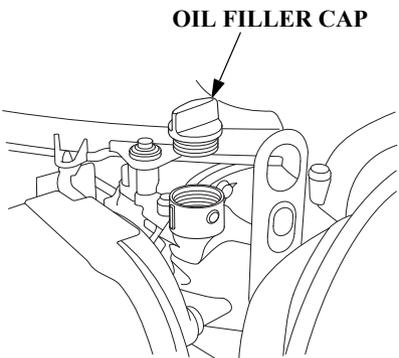

4. If the oil level is low, remove the oil filler cap, and add oil to reach the upper limit mark shown on the dipstick. Use the oil recommended on p. 70.

NOTICE

- *Running the engine with a low oil level can cause engine damage.*
- *Do not overfill. Overfilling the engine will cause it to smoke or have oil leaks.*

5. Install the oil filler cap and tighten it securely. Do not overtighten.
6. Install and lock the engine cover.

SERVICING YOUR OUTBOARD MOTOR

When you check the oil level with the dipstick, you might notice the engine oil appears milky or the oil level has increased. If you notice either condition, change the engine oil. See the following table for an explanation of these conditions.

| Operating Method | Result | Effect |
|--|--|---|
| Running the engine below 3,000 rpm for more than 30% of the time so the engine does not warm up. | <ul style="list-style-type: none">• Water condenses in the engine and mixes with the oil, resulting in a milky appearance.• Unburned fuel mixes with the oil, increasing the volume of oil. | The engine oil deteriorates, becomes less efficient as a lubricant, and causes an engine malfunction. |
| Frequent starting and stopping without allowing the engine to warm up. | | |

Engine Oil Change

An engine oil evacuation device may be used to remove the engine oil.

Drain the used oil while the engine is warm. Warm oil drains quickly and completely.

1. Unlock and remove the engine cover (p. 65).

DRAIN BOLT COVER

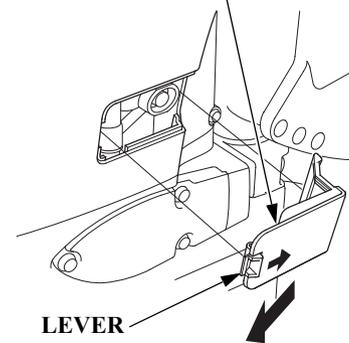

2. Push the drain bolt cover lever and remove the cover while pulling the cover backward at an angle.

SERVICING YOUR OUTBOARD MOTOR

DRAIN BOLT COVER

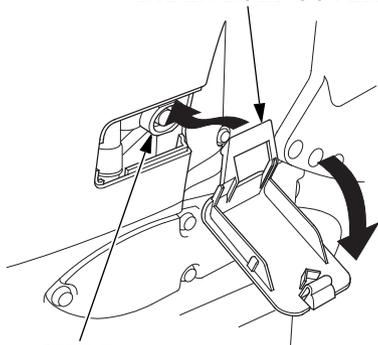

GUIDE

DRAIN BOLT COVER

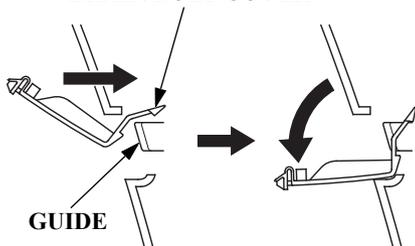

GUIDE

3. Set the drain bolt cover under the guide.

SEALING WASHER

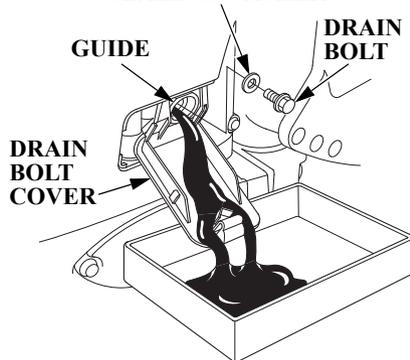

DRAIN BOLT COVER

4. Place a suitable container below the oil drain guide to catch the used oil, and then remove the oil filler cap, drain bolt, and sealing washer.

5. Allow the used oil to drain completely. Use a new sealing washer, and then reinstall the engine oil drain bolt and washer. Tighten the drain bolt securely.

DRAIN BOLT TIGHTENING TORQUE:
17 lbf·ft (23 N·m, 2.3 kgf·m)

NOTICE

Improper disposal of engine oil can be harmful to the environment. If you change your own oil, please dispose of the used oil properly. Put it in a sealed container, and take it to a recycling center. Do not throw it in the trash, pour it on the ground or down a drain.

DRAIN BOLT COVER

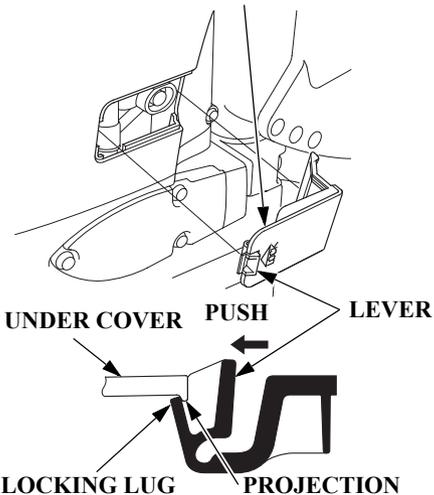

SERVICING YOUR OUTBOARD MOTOR

6. Install the oil drain bolt cover. Push the lever of the oil drain bolt cover in the direction pointed by the arrow mark of “LOCK”, and install the oil drain bolt cover so that the locking lug securely sets on the projection of the under cover.
7. With the outboard motor in a vertical position, fill to the upper limit mark on the dipstick (p. 66) with the recommended oil.
Engine oil refill capacity:
Without oil filter change:
6.9 US qt (6.5 L)
With oil filter change:
7.1 US qt (6.7 L)
8. Install the oil filler cap and tighten it securely.
9. Install and lock the engine cover.

Oil Filter Change

1. Drain the engine oil, and then reinstall the drain bolt and sealing washer. Reinstall the drain bolt cover (see *Engine Oil Change* on p. 67).
2. Tilt the outboard motor, and place a suitable container below the oil drain guide to catch the used oil.
3. Use a suitable tool to remove the oil filter, and thoroughly drain the filter into the used oil container.

FILTER WRENCH, 65 mm
OIL FILTER

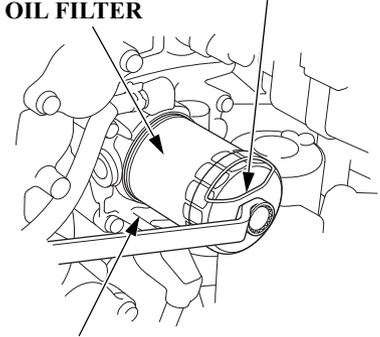

OIL DRAIN GUIDE

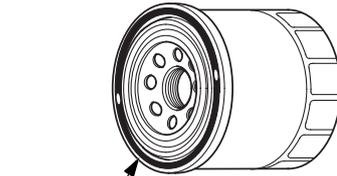

RUBBER SEAL

SERVICING YOUR OUTBOARD MOTOR

- Clean the oil filter mounting base, and coat the rubber seal of the new oil filter with clean engine oil.

NOTICE

Use only a TOHATSU Genuine oil filter or a filter of equivalent quality specified for your model. Using the wrong filter, or a non-TOHATSU filter which is not of equivalent quality, may cause engine damage.

- Screw on the new filter by hand until it contacts the engine, then use a suitable tool to tighten the filter an additional 3/4 turn.

OIL FILTER TIGHTENING

TORQUE:

9 lbf·ft (12 N·m, 1.2 kgf·m)

- Return the outboard motor to the vertical position, and fill the crankcase with the specified amount of the recommended oil.

NOTICE

Do not overfill. Overfilling the engine will cause it to smoke or have oil leaks.

- Start the engine and check for leaks (be sure the water level is at least 2 inches (5 cm) above the antiventilation plate).

If you are changing the oil filter while the outboard motor is out of the water, use commercially available ear muffs and water hose to supply water.

NOTICE

Running the outboard motor without sufficient cooling water will damage the water pump and overheat the engine.

- Stop the engine, and check the oil level as described on page 66. If necessary, add oil to bring the oil level to the upper limit mark on the dipstick.

Engine Oil Recommendations

Oil is a major factor affecting performance and service life. Use 4-stroke detergent oil.

Use 4-stroke high detergent, premium quality motor oil certified to meet or exceed U.S. automobile manufacturer's requirements for API Service category SG, SH or SJ. Motor oils classified SG, SH or SJ will show this designation on the container.

SAE 10W-30 is recommended for general use.

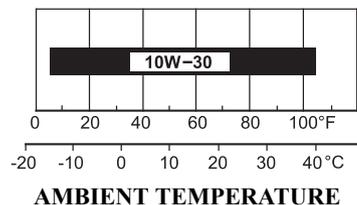

SERVICING YOUR OUTBOARD MOTOR

Lubrication Points

Apply TOHATSU Marine grease to the parts shown below:

NOTICE

Apply anticorrosion oil to pivot surfaces where grease cannot penetrate.

**THROTTLE LINK/
PIVOT/PLATE**

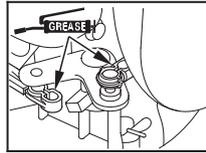

THROTTLE ROD/LINK

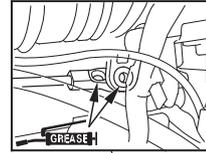

TILT BRACKET



ENGINE COVER BRACKET

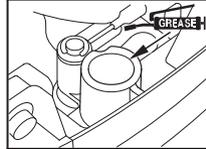

TILT SHAFT

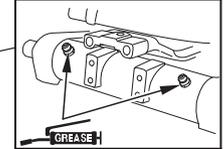

PTT THRUST RECEIVER

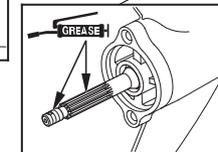
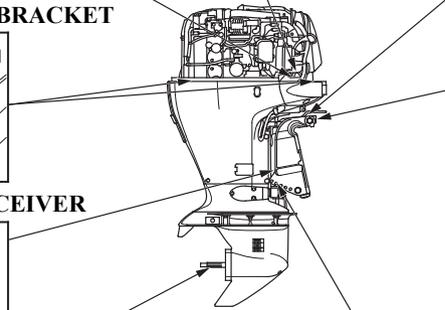

PROPELLER SHAFT

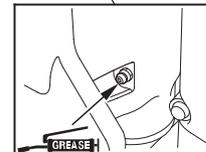

SWIVEL CASE

[Example: BFT115A]

Apply corrosion inhibitor to all areas under the engine cover and any exposed metal surfaces except the belts.

SERVICING YOUR OUTBOARD MOTOR

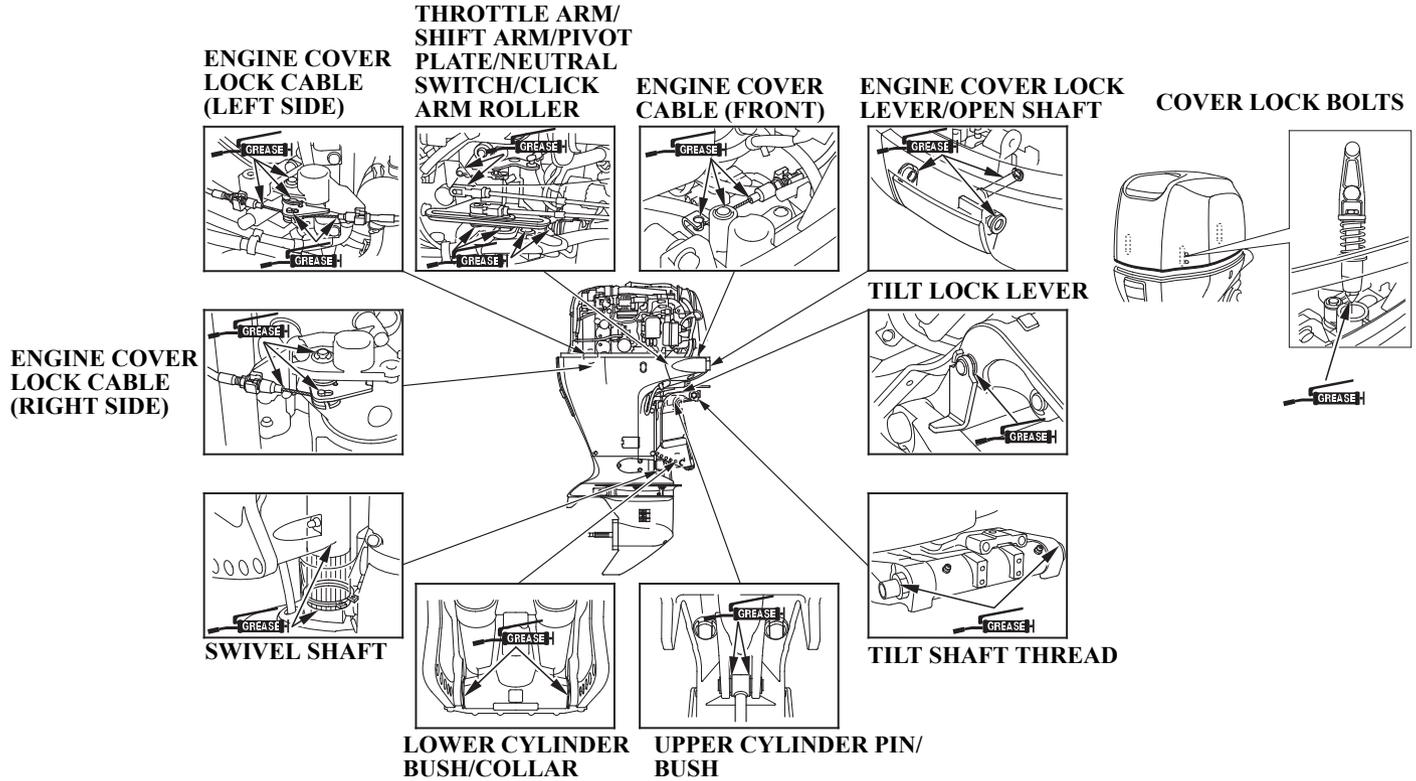

[Example: BFT115A]

SERVICING YOUR OUTBOARD MOTOR

Spark Plug Service <Standard Spark Plug>

RECOMMENDED SPARK PLUGS:
ZFR6K-11 (NGK)
KJ20DR-M11 (DENSO)

NOTICE

Incorrect spark plugs can cause engine damage.

See page 76 for instructions of handling the Iridium spark plugs (optional parts).

1. Disconnect the battery negative (-) terminal.
2. Unlock and remove the engine cover (p. 65).

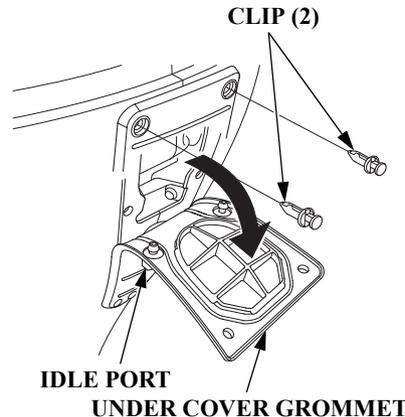
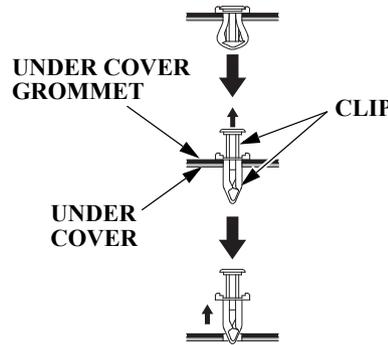
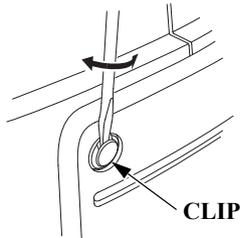

3. Remove the two clips from the upper part of the under cover grommet.
To remove the clips, raise the inner part of each clip with a screwdriver, then pull out the clips.

NOTICE

Do not try to remove the clip with force without raising the inner part of the clip. Otherwise, it can damage the clip and/or under cover.

4. Fold down the upper part of the under cover grommet without removing it from the idle port.

SERVICING YOUR OUTBOARD MOTOR

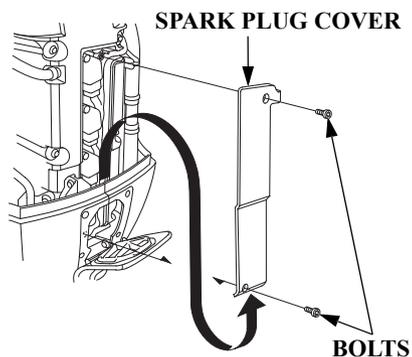

5. Remove the two bolts with the 6 mm hex. wrench, and remove the spark plug cover.

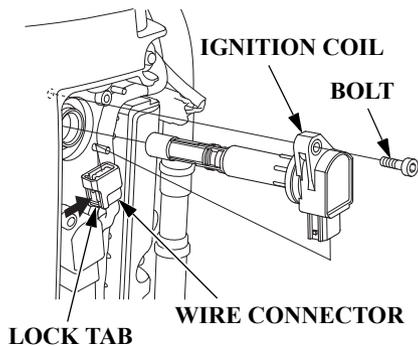

6. Use a 6 mm hex. wrench to remove the bolt holding the ignition coil. Move the ignition coil to a position that allows removal of the wire connector easily.

7. Disconnect the wire connector from the ignition coil by pushing on the lock tab and pulling on the connector. Pull on the plastic connector, not the wires.

8. Remove the ignition coil by pulling it up slightly.

NOTICE

Do not strike or drop the ignition coil, or it may be damaged and require replacement.

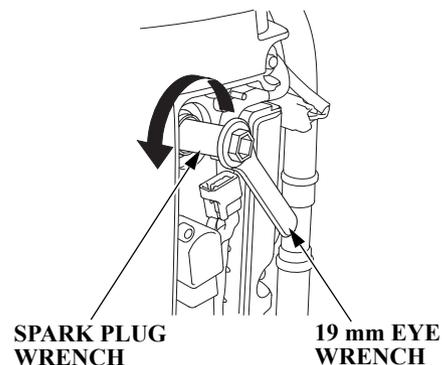

9. Remove the spark plugs with a spark plug wrench and 19 mm eye wrench.

New plug

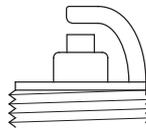

Plug needing replacement

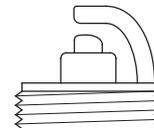

10. Inspect the spark plugs. Replace them if the electrodes are worn, or if the insulators are cracked or chipped.

SERVICING YOUR OUTBOARD MOTOR

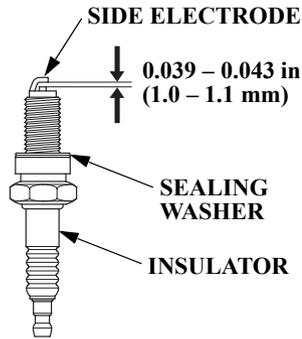

11. Measure the spark plug electrode gap with a wire-type feeler gauge. Correct the gap, if necessary, by carefully bending the side electrode. The gap should be: 0.039 – 0.043 in (1.0 – 1.1 mm)
12. Install the spark plugs carefully, by hand, to avoid cross-threading.

13. After each spark plug seats, tighten with the spark plug wrench supplied in the tool kit to compress the sealing washer.

If reinstalling used spark plugs, tighten 1/8 – 1/4 turn after the spark plugs seat.

If installing new spark plugs, tighten 1/2 turn after the spark plugs seat.

SPARK PLUG TORQUE:
13 lbf·ft (18 N·m, 1.8 kgf·m)

NOTICE

Loose spark plugs can overheat and damage the engine. Overtightening the spark plugs can damage the threads in the cylinder head.

14. Push the wire connector onto the ignition coil. Make sure it locks in place.

15. Install the ignition coil. Reinstall the bolt.
16. Repeat this procedure for the other three spark plugs.
17. Reinstall the covers. When reinstalling the covers, make sure not to jam the wire harnesses between the covers and engine case.

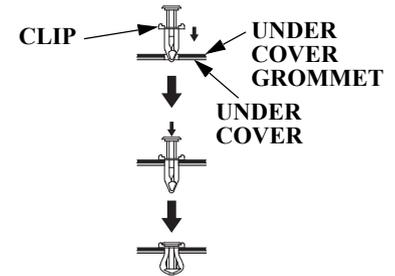

Clip installation:

- Press the under cover grommet and under cover and be sure that they adhere closely to each other.
- Insert the clips with the inner part raised off, then push in the inner part securely until they click.

SERVICING YOUR OUTBOARD MOTOR

<Optional Parts: Iridium Spark Plug>

RECOMMENDED SPARK PLUGS:
IZFR6K11 (NGK)
SKJ20DR-M11 (DENSO)

NOTICE

Incorrect spark plugs can cause engine damage.

Installation and removal procedure of the Iridium spark plugs are the same as the standard spark plugs.

These spark plugs have an iridium coated center electrode.

Be sure to observe the following when servicing iridium spark plugs.

- Do not clean the spark plugs. If an electrode is contaminated with accumulated objects or dirt, replace the spark plug with a new one.
- Use only a “wire-type feeler gauge” to check the spark plug gap if necessary. To prevent damaging the iridium coating of the center

electrode, never use a “leaf-type feeler gauge.”

The gap should be 0.039 – 0.051 inches (1.0 – 1.3 mm).

- Do not adjust the spark plug gap. If the gap is out of specification, replace the spark plug with a new one.

SERVICING YOUR OUTBOARD MOTOR

REFUELING

Check the fuel level and refill if necessary. Do not fill the fuel tank above the UPPER LIMIT. Refer to the boat manufacturer's instructions.

⚠ WARNING

Gasoline is highly flammable and explosive, and you can be burned or seriously injured when handling fuel.

- Stop the engine and let it cool before handling fuel.
- Keep heat, sparks, and flame away.
- Handle fuel only outdoors.
- Wipe up spills immediately.

Never refill the fuel tank inside a building where gasoline fumes may reach flames or sparks. Keep gasoline away from appliance pilot lights, barbecues, electric appliances, power tools, etc.

Spilled fuel is not only a fire hazard, it causes environmental damage. Wipe up spills immediately.

NOTICE

Fuel can damage paint and plastic. Be careful not to spill fuel when filling your fuel tank. Damage caused by spilled fuel is not covered under warranty.

FUEL RECOMMENDATIONS

Use unleaded gasoline with a pump octane rating of 86 or higher.

Your outboard motor is certified to operate on unleaded gasoline. Unleaded gasoline produces fewer engine and spark plug deposits and extends exhaust system life.

Never use stale or contaminated gasoline or an oil/gasoline mixture. Avoid getting dirt or water in the fuel tank.

You may use unleaded gasoline containing no more than 10% ethanol (E10) or 5% methanol by volume. In addition, methanol must contain cosolvents and corrosion inhibitors. Use of fuels with content of ethanol or methanol greater than shown above may cause starting and/or performance problems. It may also damage metal, rubber, and plastic parts of the fuel system.

SERVICING YOUR OUTBOARD MOTOR

Engine damage or performance problems that result from using a fuel with percentages of ethanol or methanol greater than shown above are not covered under warranty.

If your outboard motor will be used on an infrequent or intermittent basis, please refer to the fuel section of the *STORAGE* chapter (p. 87) for additional information regarding fuel deterioration.

Fuel Filter Inspection and Replacement

The fuel filter (inside the strainer cup) is located below the intake manifold.

Water or sediment accumulation in the filter can cause loss of power or hard starting. To prevent engine malfunction, inspect the filter and replace when necessary.

WARNING

Gasoline is highly flammable and explosive, and you can be burned or seriously injured when handling fuel.

- Stop the engine and let it cool before handling fuel.
- Keep heat, sparks, and flame away.
- Handle fuel only outdoors.
- Wipe up spills immediately.

SERVICING YOUR OUTBOARD MOTOR

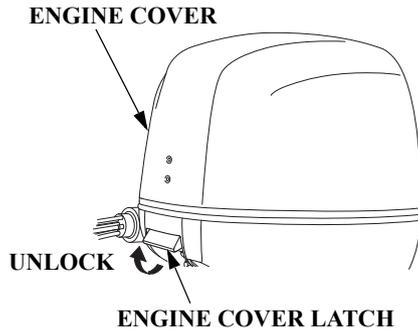

1. Remove the engine cover (p. 65).

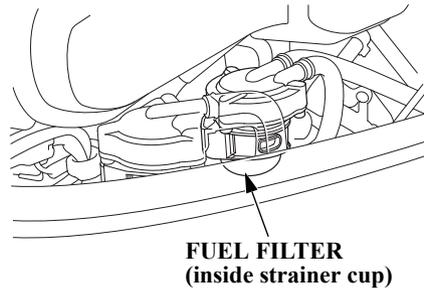

2. Looking through the translucent strainer cup, check the fuel filter for water accumulation or sediment.

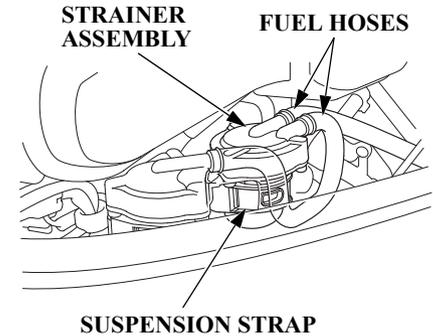

3. Remove the strainer assembly. If it is difficult to remove the strainer assembly by yourself, consult an authorized TOHATSU dealer. Remove the suspension strap from the fuel filter bracket, and then remove the strap from the fuel filter assembly.
4. Before removing the fuel filter, to prevent fuel leakage, place fuel hose clamps on the fuel hoses on each side of the fuel filter.

SERVICING YOUR OUTBOARD MOTOR

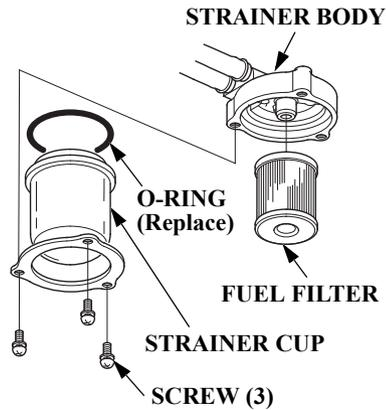

5. Remove the three screws and separate the fuel strainer cup from the strainer body.
6. Thoroughly clean the strainer cup, and replace the fuel filter.
7. Reassemble the strainer body and the cup using a new O-ring.
STRAINER TIGHTENING TORQUE:
2.5 lbf·ft (3.4 N·m, 0.35 kgf·m)

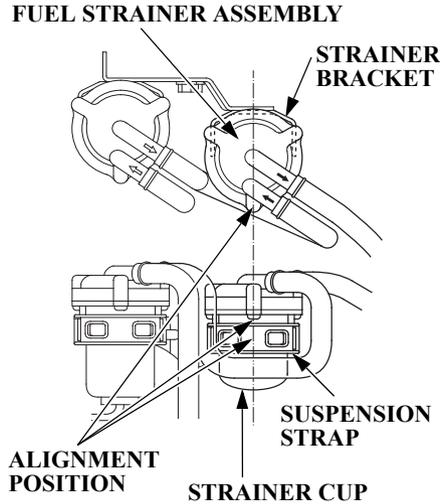

8. Align the center of suspension strap with the screw position and install the fuel strainer assembly.
9. Reinstall the strainer assembly in the original position.

10. Prime the engine using the priming bulb (p. 40). Check for fuel leaks.
Repair any fuel leaks if necessary.

If loss of power or hard starting are found to be caused by excessive water or sediment accumulation in the fuel filter, inspect the fuel tank.

Clean the fuel tank and tank filter if necessary. It may be necessary to drain the fuel tank completely and refill with fresh gasoline.

SERVICING YOUR OUTBOARD MOTOR

Water Separator Inspection and Service

INTAKE MANIFOLD

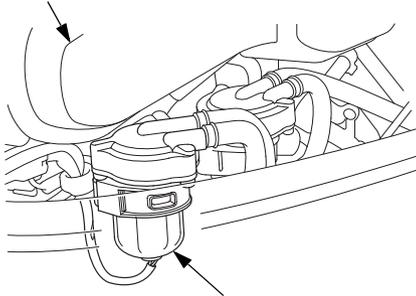

WATER SEPARATOR

The water separator is located below the intake manifold. Water accumulation in the water separator can cause loss of power or hard starting. Check the water separator periodically. Clean it or consult with an authorized TOHATSU dealer for cleaning.

⚠ WARNING

Gasoline is highly flammable and explosive, and you can be burned or seriously injured when handling fuel.

- Stop the engine and let it cool before handling fuel.
- Keep heat, sparks, and flame away.
- Handle fuel only outdoors.
- Wipe up spills immediately.

1. Remove the engine cover (p. 65).
2. Remove the separator assembly. If it is difficult to remove the separator assembly by yourself, consult an authorized TOHATSU dealer.

SEPARATOR ASSEMBLY

FUEL TUBES

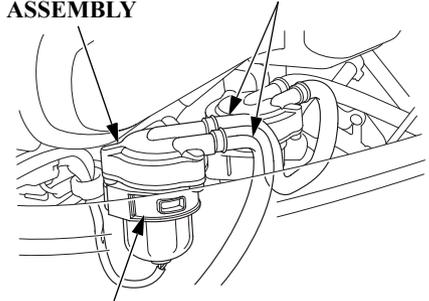

SUSPENSION STRAP

Remove the suspension strap from the water separator bracket; then remove the strap from the separator assembly.

During removal of the separator assembly, take care not to damage the wire harness with the separator bracket.

3. Pinch the fuel tubes with tube clamps to prevent fuel leakage.

SERVICING YOUR OUTBOARD MOTOR

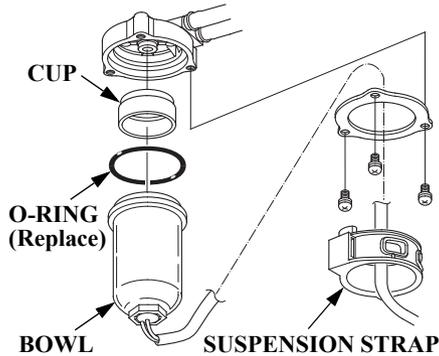

4. Remove the three screws and separate the bowl from the body.
5. Thoroughly clean the bowl.
6. Reassemble the water separator bowl and cup. Use a new O-ring.
TIGHTENING TORQUE:
2.5 lbf·ft (3.4 N·m, 0.35 kgf·m)

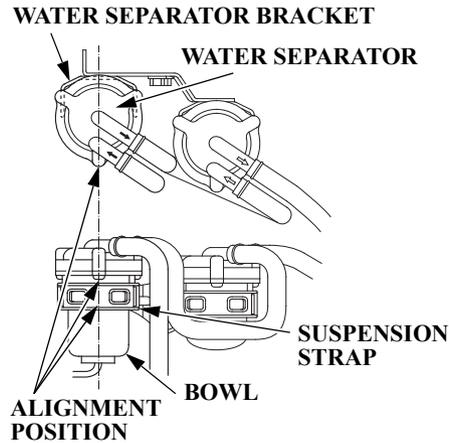

7. Align the center of suspension strap with the screw position and install the water separator assembly.
8. Reinstall the water separator in the reverse order of removal.

9. Squeeze and release the priming bulb to fill the vapor separator, and check for fuel leaks. Repair any fuel leaks if necessary.

If the buzzer sounds or water or sediment accumulation are found to be caused by excessive water or sediment accumulation in the fuel filter, inspect the fuel tank.

Clean the fuel tank and tank filter if necessary. It may be necessary to drain the fuel tank completely and refill with fresh gasoline.

SERVICING YOUR OUTBOARD MOTOR

Anode Replacement

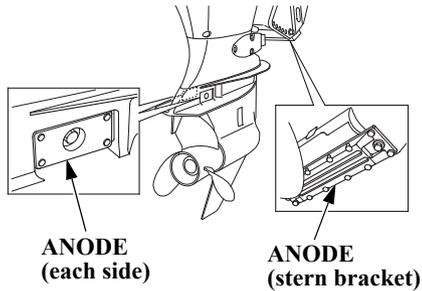

The anodes are located on each side of the gear case and on the stern bracket. They are made of a sacrificial material that helps to protect the outboard motor from corrosion.

Replace the anodes when they have been reduced to about one third their original size, or if they are crumbling.

NOTICE

Painting or coating the anodes will defeat their purpose and will lead to rust and corrosion damage to the outboard motor. The anodes must be exposed to the water in order to protect the outboard motor.

Propeller Replacement

Before replacing the propeller, remove the emergency stop switch clip from the emergency stop switch to prevent any possibility of the engine being started while you are working with the propeller.

The propeller blades may have sharp edges, so wear heavy gloves to protect your hands.

Operating the outboard motor at higher altitudes will reduce available power. This may require decreasing the propeller pitch to maintain correct engine RPM.

Removal

1. Remove the cotter pin, unscrew the castle nut, remove the washer, and then remove the propeller and thrust washer.
2. Inspect the propeller shaft for any fishing line or debris.

SERVICING YOUR OUTBOARD MOTOR

Installation

1. Apply marine grade grease to the propeller shaft.
2. Install the thrust washer with the grooved side toward the gear case.
3. Install the propeller.
4. Install the washer with as shown.
5. Lightly tighten the castle nut by hand or wrench until the propeller has no free play.
6. Tighten the castle nut using a torque wrench.
CASTLE NUT TIGHTENING TORQUE:
0.7 lbf-ft (1 N·m, 0.1 kgf·m)
7. Then, using a torque wrench, tighten the castle nut until the first available groove in the castle nut aligns with the cotter pin hole. Do not tighten past the first alignment

of the castle nut groove and the cotter pin hole.

NOTICE

TIGHTENING TORQUE LIMIT:

33 lbf-ft (44 N·m, 4.5 kgf·m)

Do not tighten the castle nut above the TIGHTENING TORQUE LIMIT, or the propeller and shaft may be damaged.

8. Be sure to replace the cotter pin with a new one.

- Use a TOHATSU Genuine stainless steel cotter pin or equivalent cotter pin and bend the pin ends as shown.

Note that these wrenches are not included with the tool set that comes with the outboard motor. Contact your authorized TOHATSU dealer for additional tool information.

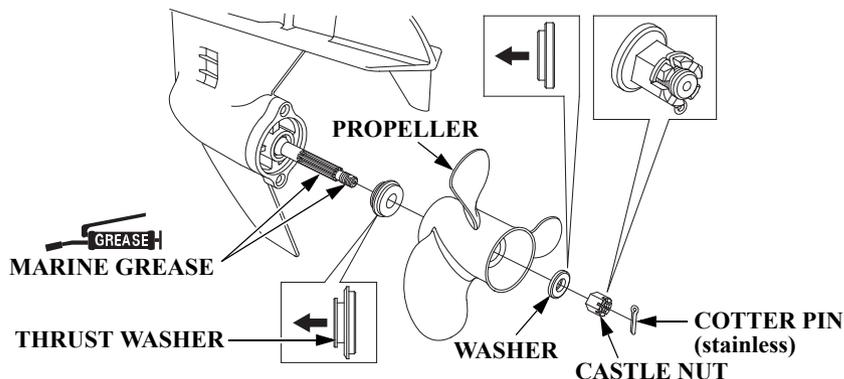

CLEANING AND FLUSHING

Cleaning and Flushing

After each use in salt water or dirty water, thoroughly clean and rinse the outboard motor with fresh water.

Touch up any damaged paint, and coat areas that may rust with corrosion inhibitor. Lubricate controls with a silicone spray lubricant.

NOTICE

Do not apply water or corrosion inhibitor directly to the electrical components under the engine cover, such as the AC generator, HO2S sensor, or the AC generator belt. If water or corrosion inhibitor penetrates these components, they may be damaged. Before applying a corrosion inhibitor, cover the AC generator, belt and HO2S sensor with a protective material to prevent damage.

Cleaning

Wash the outside of the outboard motor with clean, fresh water, and flush the cooling system as follows.

Flushing With a Garden Hose (commercially available)

NOTICE

Do not run the engine when flushing the outboard motor with a garden hose or the outboard motor may be damaged.

For safety, remove the emergency stop switch clip so the engine cannot be started while you are standing near the propeller.

1. Disconnect the fuel hose from the outboard motor.
2. Tilt down the outboard motor.
3. Clean and wash the outside of the outboard motor with fresh water.

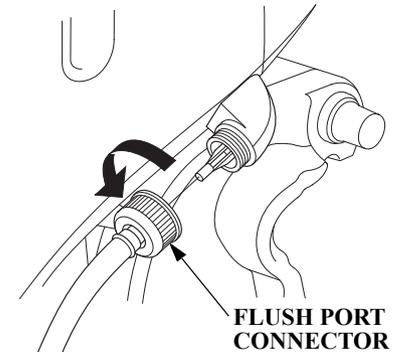

4. Disconnect the flush port connector.

CLEANING AND FLUSHING

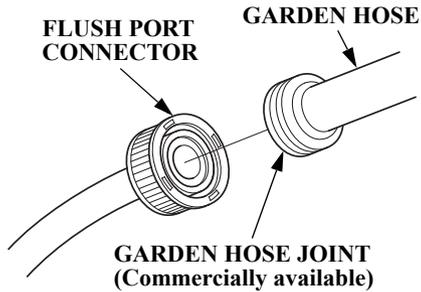

5. Screw the flush port connector onto the garden hose.

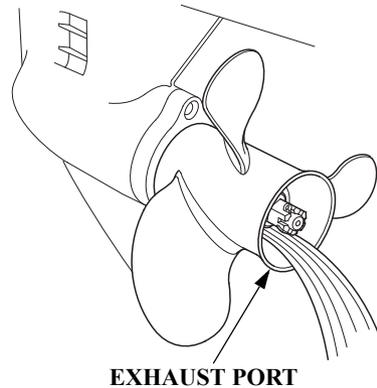

6. Turn on the fresh water supply and flush the outboard motor for at least 10 minutes.
7. After flushing, disconnect the garden hose and reconnect the flush port connector.
8. Tilt up the outboard motor and move the tilt lock lever to the LOCK position.

Fuel

NOTICE

Depending on the region where you operate your outboard, fuel formulations may deteriorate and oxidize rapidly. Fuel deterioration and oxidation can occur in as little as 15 days and may cause damage to the fuel system. Please check with your servicing dealer for local storage recommendations.

Gasoline will oxidize and deteriorate in storage. Old gasoline will cause hard starting, and it leaves gum deposits that clog the fuel system. If the gasoline in your fuel tank and vapor separator deteriorates during storage, you may need to have the vapor separator and other fuel system components serviced or replaced.

The length of time that gasoline can be left in your fuel tank and vapor separator without causing functional problems will vary with such factors

as gasoline blend, your storage temperatures, and whether the fuel tank is partially or completely filled. The air in a partially filled fuel tank promotes fuel deterioration. Very warm storage temperatures accelerate fuel deterioration. Fuel deterioration problems may occur in less than 15 days, if the gasoline was not fresh when you filled the fuel tank.

You can avoid fuel deterioration problems by draining all the fuel from the fuel tank and vapor separator.

STORAGE

Draining the Fuel System

You can avoid fuel deterioration problems by draining the fuel tank and vapor separator.

FRONT BRACKET CLAMP

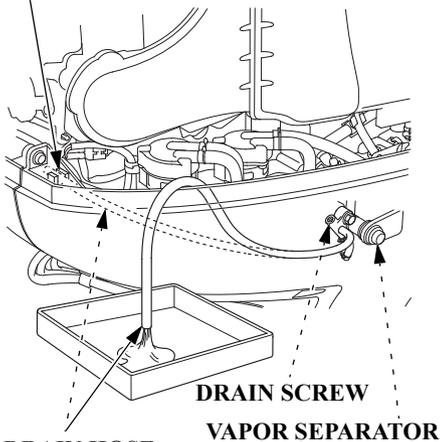

DRAIN HOSE
(Draining the fuel becomes easier when the front end of the drain hose is as low as possible)

DRAIN SCREW

VAPOR SEPARATOR

1. Unhook the drain hose from the front bracket clamp.
2. Set the end of the hose toward the outside of the engine undercase. Place an approved gasoline container below the fuel drain outlet, and use a funnel to avoid spilling fuel.
3. Loosen the vapor separator drain screw.

⚠ WARNING

Gasoline is highly flammable and explosive, and you can be burned or seriously injured when handling fuel.

- Stop the engine and let it cool before handling fuel.
- Keep heat, sparks, and flame away.
- Handle fuel only outdoors.
- Wipe up spills immediately.

4. Tilt the outboard motor up all the way. Leave the outboard motor tilted up until the gasoline stops flowing.
5. After thoroughly draining, tighten the drain screw securely and return the outboard motor to the vertical position.
6. Clamp the drain hose on the front bracket clamp.
7. Drain the fuel tank into an approved gasoline container.

Engine Oil

1. Change the engine oil and the oil filter (p. 66 – 70).
2. Remove the spark plugs (p. 73), and remove the emergency stop switch clip from the emergency stop switch.
3. Pour 1 – 2 teaspoons (5 – 10 cm³) (p. 104) of clean engine oil into each cylinder.
4. Rotate the engine a few revolutions to distribute the oil in the cylinders.
5. Reinstall the spark plugs (p. 75).

STORAGE

HOISTING THE OUTBOARD MOTOR

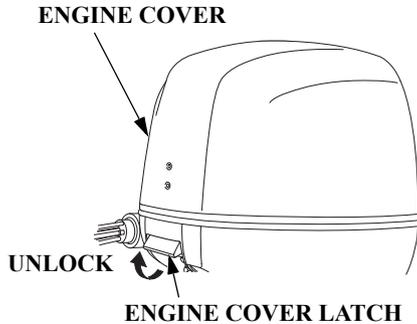

1. Remove the engine cover (p. 65).

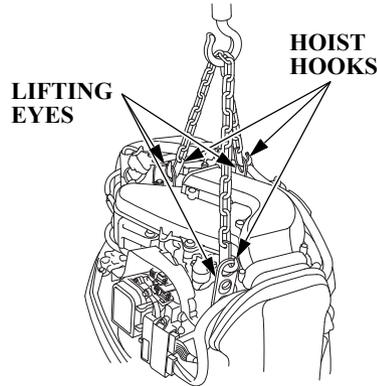

2. Attach the hoist hooks to the lifting eyes.
3. Disconnect the outboard motor from the boat, hoist the outboard motor, and move it to the storage area.
4. After the outboard motor is placed in storage and disconnected from the hoist, install the engine cover.

STORAGE PRECAUTIONS

Select a well-ventilated storage area. If possible, avoid storage areas with high humidity.

If storing a container of gasoline, store it away from any appliance that operates with a flame, such as a furnace, water heater, or clothes dryer. Also avoid any area with a spark producing electric motor, or where power tools are operated.

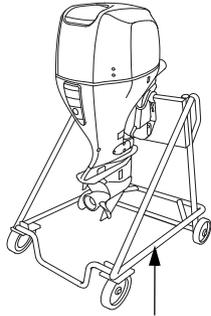

OUTBOARD MOTOR STAND

If the outboard motor will be removed from the boat for storage, we recommend storing it vertically by mounting it on a commercially available stand.

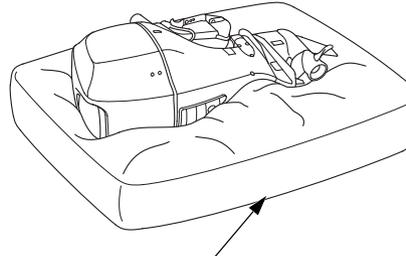

PROTECTOR

If it is necessary to store the outboard motor horizontally as shown, drain the vapor separator (p. 88), and drain the engine oil (p. 67), before removing the outboard motor from the boat.

Rest the outboard motor on a cushion of protective material.

Cover the outboard motor to keep out dust. Do not use plastic sheet as a dust cover. A nonporous cover will trap moisture, promoting rust and corrosion.

REMOVAL FROM STORAGE

Check your outboard motor as described in the *BEFORE OPERATION* chapter of this manual.

If the cylinders were coated with oil during storage preparation, the engine may smoke briefly at startup. This is normal.

TRANSPORTING

WITH OUTBOARD MOTOR INSTALLED ON BOAT

When trailering a boat with the outboard motor attached, always disconnect the fuel line from the fuel tank.

Use an outboard motor support bar to prevent the outboard motor from moving while trailering the boat. Refer to the manufacturer's instructions for using an outboard motor support bar.

The preferred method is to leave the engine in the normal running position, but if there is insufficient road clearance, you can tilt the outboard motor using a commercially available outboard motor support bar available through your dealer. Refer to the manufacturer's instructions for using an outboard motor support bar.

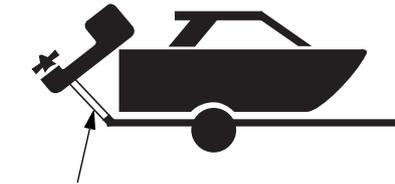

**OUTBOARD MOTOR SUPPORT BAR
(commercially available)**

WITH OUTBOARD MOTOR REMOVED FROM BOAT

Secure the outboard motor in either the vertical or horizontal position shown on p. 91.

TAKING CARE OF UNEXPECTED PROBLEMS

ELECTRIC STARTER WILL NOT OPERATE

| Possible Cause | Correction |
|--|---|
| Battery connections loose or corroded. | Clean and tighten battery connections. |
| Battery discharged. | Recharge battery. |
| Fuse(s) blown. | Replace fuse(s) (p. 98). |
| Fuel system malfunction, fuel pump failure, ignition malfunction, stuck valves, starter malfunction, switch malfunction, or electrical problem in the starting circuit, etc. | Use starting procedure (p. 41, 44, 46); if engine still will not start, then take outboard motor to an authorized TOHATSU dealer, or refer to the service manual. |

TAKING CARE OF UNEXPECTED PROBLEMS

ENGINE WILL NOT START

| Possible Cause | Correction |
|---|--|
| Clip not inserted in emergency stop switch. | Insert clip in emergency stop switch. |
| Control lever not in neutral position. | Shift to neutral. |
| Fast idle lever raised (side-mount type). | Leave fast idle lever OFF (p. 42). |
| Out of fuel. | Refuel (p. 77). |
| Fuel hose not primed. | Squeeze priming bulb (p. 40). |
| Fuel filter or fuel tank filter clogged. | Replace fuel filters (p. 78). |
| Bad fuel; outboard motor stored without draining gasoline, or refueled with bad gasoline. | Drain fuel tank and vapor separator (p. 88). Refill with fresh gasoline (p. 77). |

TAKING CARE OF UNEXPECTED PROBLEMS

ENGINE WILL NOT START

| Possible Cause | Correction |
|--|--|
| Water separator full of water accumulation. | Clean water separator (p. 81). |
| Spark plugs faulty, fouled, or improperly gapped. | Gap (non-iridium type) or replace spark plugs (p. 73). |
| Spark plugs wet with fuel (flooded engine). | Dry and reinstall spark plugs. Start engine with the throttle open. |
| Fuel system malfunction, fuel pump failure, ignition malfunction, etc. | Take outboard motor to an authorized TOHATSU dealer, or refer to the service manual. |

TAKING CARE OF UNEXPECTED PROBLEMS

HARD STARTING OR STALLS AFTER STARTING

| Possible Cause | Correction |
|---|--|
| Fast idle lever raised (side-mount type). | Leave fast idle lever OFF (p. 42). |
| Fuel hose not primed. | Squeeze priming bulb (p. 40). |
| Fuel filter or fuel tank filter clogged. | Replace fuel filters (p. 78). |
| Bad fuel; outboard motor stored without draining gasoline, or refueled with bad fuel. | Drain fuel tank and vapor separator (p. 88). Refill with fresh gasoline (p. 77). |
| Water separator full of water accumulation. | Clean water separator (p. 81). |

TAKING CARE OF UNEXPECTED PROBLEMS

HARD STARTING OR STALLS AFTER STARTING

| Possible Cause | Correction |
|--|--|
| Spark plugs faulty, fouled, or improperly gapped. | Gap (non-iridium type) or replace spark plugs (p. 73). |
| Fuel system malfunction, fuel pump failure, ignition malfunction, etc. | Take outboard motor to an authorized TOHATSU dealer, or refer to the service manual. |

ENGINE OVERHEATS

| Possible Cause | Correction |
|----------------------------------|--|
| Water intake screens clogged. | Clean water intake screens. |
| Faulty thermostat or water pump. | Take outboard motor to an authorized TOHATSU dealer, or refer to the service manual. |

TAKING CARE OF UNEXPECTED PROBLEMS

FUSES

Electric Starter Will Not Operate

The 10 A, 15 A, and 30 A main fuses protect the electric starter relay and related circuits.

The 10 A (No. 5) main fuse protects the ignition switch and related circuits. If this fuse blows, the engine will not start or run, and the power trim/tilt switch will not activate the trim/tilt mechanism.

Battery Will Not Charge

A 100 A ACG fuse protects the alternator circuit. If the ACG fuse blows, the engine will not charge the battery. Refer to p. 100.

Fuse Replacement

NOTICE

Disconnect the battery cable at the battery negative (-) terminal before replacing the fuse.

Failure to do so may cause a short circuit.

Main Fuse

1. Stop the engine and disconnect the battery cable.
2. Remove the engine cover.

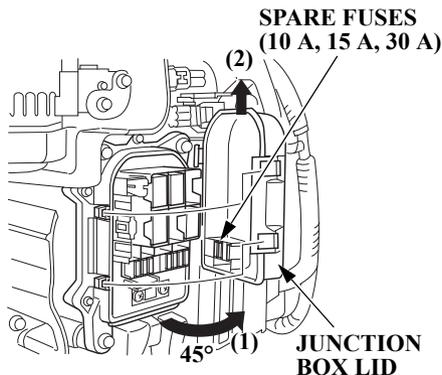

3. Remove the junction box lid.

FUSE PULLER

RELAYS

(Do not remove the relays)

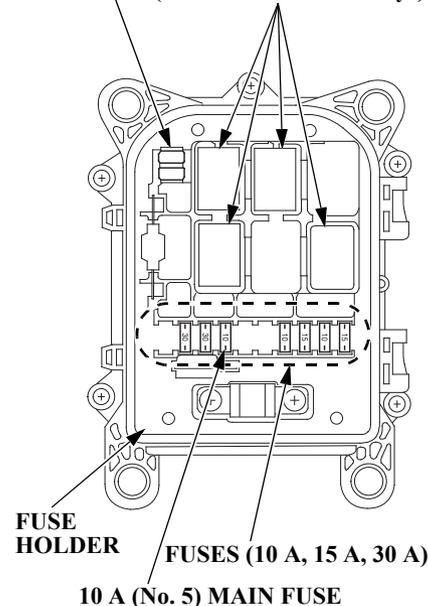

TAKING CARE OF UNEXPECTED PROBLEMS

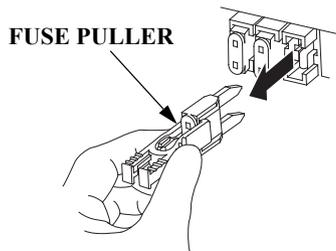

BLOWN FUSE

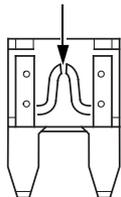

4. Use the fuse puller from the fuse holder to remove the fuses. If a fuse is blown, install a replacement fuse of the same specified rating. The outboard motor is supplied with spare fuses in the junction box lid.

MAIN FUSE RATINGS:

10 A, 15 A, 30 A

5. Reinstall the junction box lid, and the engine cover.
6. Reconnect the battery.

NOTICE

Never use a fuse with a rating greater than specified. Serious damage to the electrical system could result.

If a blown fuse is found, try to determine and correct the electrical problem that caused the blown fuse. An uncorrected electrical problem may cause the fuse to blow again.

If fuses continue to blow, take the outboard motor to an authorized TOHATSU dealer for inspection and service, or refer to the service manual.

TAKING CARE OF UNEXPECTED PROBLEMS

ACG Fuse

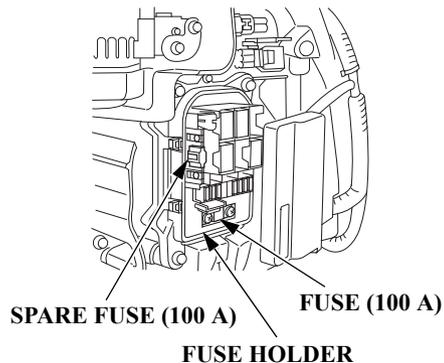

1. Stop the engine and disconnect the battery cable.
2. Remove the engine cover.
3. Remove the junction box lid (see page 98).
4. Remove the old fuse by removing two 5 mm screws.

5. Install a new fuse with the "100 A."

ACG FUSE: 100 A

6. Reinstall the junction box lid, and the engine cover.
7. Reconnect the battery.

A spare fuse is located on the fuse holder.

OIL PRESSURE INDICATOR TURNS OFF AND ENGINE SPEED IS LIMITED

Side-Mount Type

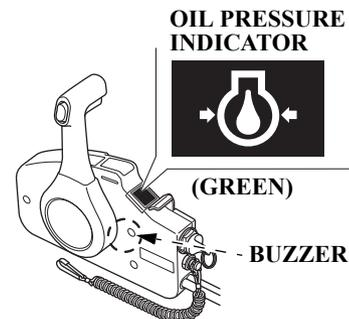

Panel-Mount/Top-Mount Types

OIL PRESSURE INDICATOR

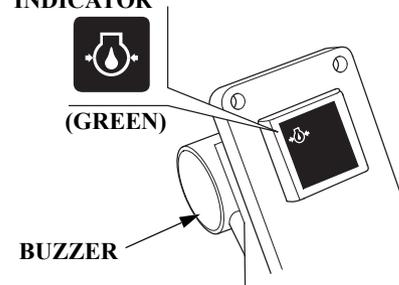

TAKING CARE OF UNEXPECTED PROBLEMS

If oil pressure becomes low, the oil pressure indicator will turn off, and the engine protection system limits engine speed. If you are at cruising speed, engine speed will decrease automatically.

The oil pressure indicator is also equipped with a buzzer that sounds when the oil pressure indicator turns off.

Low oil pressure may be the result of a low engine oil level, or there may be a problem with the engine lubrication system.

If the throttle is closed suddenly after full throttle operation, engine speed may drop below the specified idle rpm, and that could activate the engine protection system momentarily.

If low oil pressure activates the engine protection system, stop the engine, check the engine oil level (p. 66), and add oil if needed.

With the engine oil at the recommended level, restart the engine. If the lubrication system is OK, the oil pressure indicator should come on within 30 seconds, and the engine will respond normally to throttle control lever operation.

If the engine protection system remains activated after 30 seconds, return to the nearest boat landing, and have the outboard motor inspected by an authorized TOHATSU dealer.

OVERHEAT INDICATOR COMES ON AND ENGINE SPEED IS LIMITED

Side-Mount Type

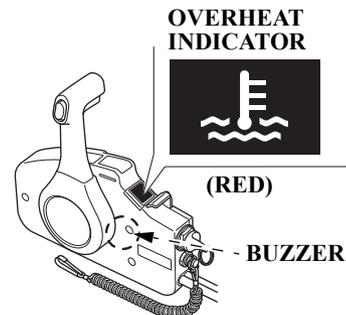

Panel-Mount/Top-Mount Types

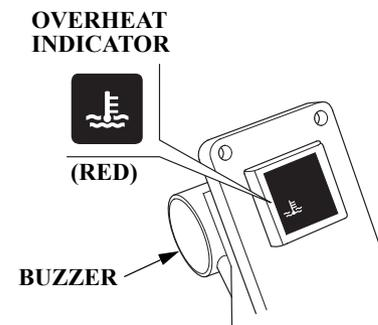

TAKING CARE OF UNEXPECTED PROBLEMS

If the engine overheats, the overheat indicator will come on, and the engine will stop in 20 seconds after the engine protection system limits engine speed. If you are at cruising speed, engine speed will decrease automatically.

All types are equipped with a buzzer that sounds when the overheat indicator comes on.

Engine overheating may be the result of restricted water intake screens, or there may be a problem with the cooling system thermostat or water pump.

If the engine is stopped after running at full throttle, and then restarted soon afterward, that could activate the engine protection system momentarily.

COOLING SYSTEM INDICATOR

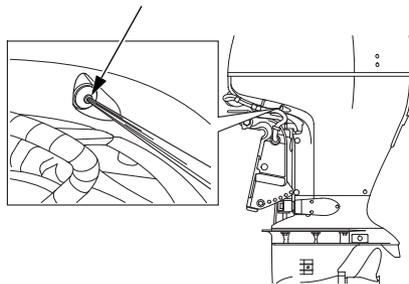

If overheating activates the engine protection system, idle the engine in neutral, and check the cooling system indicator.

If water is flowing from the cooling system indicator, continue idling for 30 seconds. If the cooling system is OK, the overheat indicator should go off within 30 seconds, and the engine will respond normally to throttle control lever operation.

If there is no water flowing from the cooling system indicator, stop the engine, and tilt the outboard motor to inspect the water intake screens. If restricted, clean the water intake screens, return the outboard motor to the running position, restart the engine, and check the cooling system indicator again.

If there is still no water flowing from the cooling system indicator, or if the engine protection system remains activated after 30 seconds, return to the nearest boat landing, and have the outboard motor inspected by an authorized TOHATSU dealer.

TAKING CARE OF UNEXPECTED PROBLEMS

WATER SEPARATOR BUZZER SOUNDS

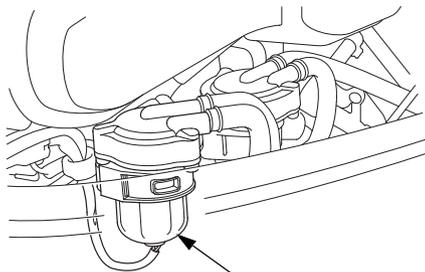

WATER SEPARATOR

When the water separator buzzer sounds (a rapid, repeating signal):

Check the water separator for water contamination. If water is present, stop the engine, and clean the water separator following the instructions on page 81, or consult with an authorized TOHATSU dealer.

SUBMERGED OUTBOARD MOTOR

A submerged outboard motor must be serviced immediately after it is recovered from the water in order to minimize corrosion.

If there is a TOHATSU dealership nearby, take the outboard motor to the dealer immediately. If you are far from a dealership, proceed as follows:

1. Remove the engine cover, and rinse the outboard motor with fresh water to remove salt water, sand, mud, etc.
2. Drain the vapor separator as described on p. 88.

3. Change the engine oil and oil filter as described on p. 66 – 70. If there was water in the engine crankcase, or if the used engine oil showed signs of water contamination, then a second engine oil change should be performed after running the engine for half an hour.
4. Remove the spark plugs (p. 73). Operate the starter to expel water from the engine's cylinder.

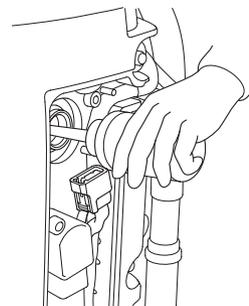

TAKING CARE OF UNEXPECTED PROBLEMS

5. Pour a teaspoon (p. 89) of engine oil into each spark plug hole to lubricate the inside of the cylinders. Reinstall the spark plugs.

If the engine was running when it submerged, there may be mechanical damage, such as bent connecting rods. If the engine binds when cranked, do not attempt to run the engine until it has been repaired.

6. Attempt to start the engine (be sure the water level is at least 2 inches above the antiventilation plate).

If you are changing the oil filter while the outboard motor is out of the water, use commercially available ear muffs and water hose to supply water.

NOTICE

Running the outboard motor without sufficient cooling water will damage the water pump and overheat the engine.

If the engine fails to start, remove the spark plugs and dry them, then reinstall the spark plugs and attempt to start the engine again.

If the engine starts, and no mechanical damage is evident, continue to run the engine for a half hour or longer. Be sure the water level is at least 2 inches (5 cm) above the antiventilation plate to avoid overheating and water pump damage.

7. As soon as possible, take the outboard motor to an authorized TOHATSU dealer for inspection and service.

TECHNICAL INFORMATION

Serial Number Locations

Record the product identification number, the engine serial number, and the date of purchase in the space provided on this page. You will need these numbers when ordering parts, and when making technical or warranty inquiries.

PRODUCT IDENTIFICATION NUMBER

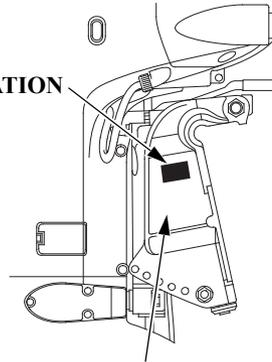

RIGHT STERN BRACKET

The product identification number is stamped on a plate attached on the right side of the stern bracket.

Product identification number:

Date of purchase:

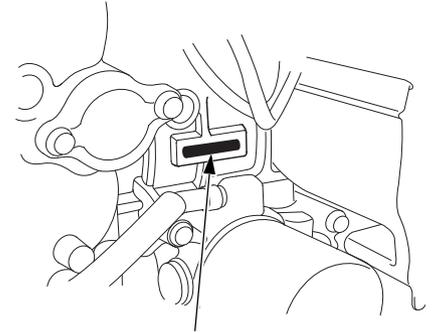

ENGINE SERIAL NUMBER

The engine serial number is stamped on the upper right side of the engine.

Engine serial number:

TECHNICAL INFORMATION

Battery

For complete information, refer to the battery manufacturer's instructions.

Minimum Requirements

12V – 64Ah/5HR (80Ah/20HR)
(CCA622)

NOTICE

- *Be careful to avoid connecting the battery in reverse polarity, as this will damage the battery-charging system in the outboard motor.*
- *Do not disconnect the battery cables while the engine is running. Disconnecting the cables while the engine is running will damage the outboard motor's electrical system.*
- *Battery cable extension: Extending the original battery cable will cause the battery voltage to drop due to the increased length of the cable and number of connections. This voltage drop may cause the buzzer to sound momentarily when*

engaging the starter motor and may prevent the engine from starting. If the engine starts and the buzzer sounds momentarily, there may be barely sufficient voltage reaching the engine.

WARNING: Battery posts, terminals, and related accessories contain lead and lead compounds.

Wash your hands after handling.

Emission Control System Information

Source of Emissions

The combustion process produces carbon monoxide, oxides of nitrogen, and hydrocarbons. Control of hydrocarbons and oxides of nitrogen is very important because, under certain conditions, they react to form photochemical smog when subjected to sunlight. Carbon monoxide does not react in the same way, but it is toxic.

TOHATSU utilizes appropriate air/fuel ratios and other emissions control systems to reduce the emissions of carbon monoxide, oxides of nitrogen, and hydrocarbons.

PGM-FI System

The PGM-FI system uses sequential multiport fuel injection. It has three subsystems: Air Intake, Engine Control, and Fuel Control. The Engine Control Module (ECM) uses various sensors to determine how much air is going into the engine. It then controls how much fuel to inject under all operating conditions.

Ignition Timing Control System

The system constantly adjusts the ignition timing, reducing the amount of HC, CO, and NO_x produced.

The U.S. and California Clean Air Acts

EPA and California regulations require all manufacturers to furnish written instructions describing the operation and maintenance of emission control systems.

The following instructions and procedures must be followed in order to keep the emissions from your TOHATSU engine within the emission standards.

Tampering and Altering

NOTICE

Tampering is a violation of Federal and California law.

Tampering with or altering the emission control system may increase emissions beyond the legal limit. Among those acts that constitute tampering are:

- Removal or alteration of any part of the intake, fuel, or exhaust systems.
- Alterations that would cause the engine to operate outside its design parameters.

TECHNICAL INFORMATION

Problems That May Affect Emissions

If you are aware of any of the following symptoms, have your engine inspected and repaired by your servicing dealer.

- Hard starting or stalling after starting
- Rough idle
- Misfiring or backfiring under load
- Afterburning (backfiring)
- Black exhaust smoke or high fuel consumption

Replacement Parts

The emission control systems on your TOHATSU engine were designed, built, and certified to conform with EPA and California emission regulations. We recommend the use of TOHATSU Genuine parts whenever you have maintenance done. These original-design replacement parts are manufactured to the same standards as the original parts, so you can be confident of their performance. The use of replacement parts that are not of the original design and quality may impair the effectiveness of your emission control system.

A manufacturer of an aftermarket part assumes the responsibility that the part will not adversely affect emission performance. The manufacturer or rebuilder of the part must certify that use of the part will not result in a failure of the engine to comply with emission regulations.

Maintenance

Follow the maintenance schedule on page 62 and 63. Remember that this schedule is based on the assumption that your machine will be used for its designed purpose. Sustained high-load operation, or use in unusual conditions, will require more frequent service.

Star Label

US, Puerto Rico, and US Virgin Islands

A Star label was applied to this outboard motor in accordance with the requirements of the California Air Resources Board.

The Star Label means Cleaner Marine Engine

This engine has been certified as a:



The Symbol for Cleaner Marine Engines:

Cleaner Air and Water - for healthier lifestyle and environment.

Better Fuel Economy - burns up to 30 - 40 percent less gas and oil than conventional carbureted two-stroke engines, saving money and resources.

Longer Emission Warranty - protects consumer for worry-free operation.

TECHNICAL INFORMATION



**One Star
Low
Emission**

The one-star label identifies engines that meet the Air Resources Board's Personal Watercraft and Outboard marine engine 2001 exhaust emission standards. Engines meeting these standards have 75% lower emissions than conventional carbureted two-stroke engines. These engines are equivalent to the U.S. EPA's 2006 standards for marine engines.



**Two Stars
Very Low
Emission**

The two-star label identifies engines that meet the Air Resources Board's Personal Watercraft and Outboard marine engine 2004 exhaust emission standards. Engines meeting these standards have 20% lower emissions than One Star-Low Emission engines.



**Three Stars
Ultra Low
Emission**

The three-star label identifies engines that meet the Air Resources Board's Personal Watercraft and Outboard marine engine 2008 exhaust emission standards or the Sterndrive and Inboard marine engine 2003-2008 exhaust emission standards. Engines meeting these standards have 65% lower emissions than One Star-Low Emission engines.



**Four Stars
Super Ultra
Low Emission**

The four-star label identifies engines that meet the Air Resources Board's Sterndrive and Inboard marine engine 2009 exhaust emission standards. Personal Watercraft and Outboard marine engines may also comply with these standards. Engines meeting these standards have 90% lower emissions than One Star-Low Emission engines.

Cleaner Watercraft - Get the Facts
1-800-END-SMOG
www.arb.ca.gov

TECHNICAL INFORMATION

Specifications

| | | | |
|--|---|---------------------|---------------------|
| MODEL | BFT115A | | |
| Description code | BBHJ | | |
| Type | LA | XA | XCA |
| Overall length | 33.3 in (845 mm) | | |
| Overall width | 22.8 in (580 mm) | | |
| Overall height | 65.6 in (1,665 mm) | 70.5 in (1,790 mm) | |
| Transom height (when transom angle at 12°) | 20.0 in (508 mm) | 25.0 in (635 mm) | |
| Dry mass [weight]* | 478 lbs (217 kg) | 485 lbs (220 kg) | 492 lbs (223 kg) |
| Rated power | 85.8 kW (115 HP) | | |
| Full throttle range | 4,500 – 6,000 rpm | | |
| Engine type | 4 stroke DOHC in-line 4-cylinder | | |
| Displacement | 143.6 cu-in (2,354 cm ³) | | |
| Spark plug gap | 0.039 – 0.043 in (1.0 – 1.1 mm) | | |
| Starter system | Electric starter | | |
| Ignition system | Fully transistorized, battery ignition | | |
| Lubrication system | Trochoid pump pressure lubrication | | |
| Specified oil | Engine: API standard (SG, SH, SJ) SAE 10W-30 Gear case: API standard (GL-4) SAE 90 Hypoid gear oil | | |
| Oil capacity | Engine: 6.9 US qt (6.5 L) without oil filter change 7.1 US qt (6.7 L) with oil filter change Gear case: 1.04 US qt (0.98 L) | | |

| | |
|---|---|
| CARB star label | ULTRA · LOW EMISSION |
| D.C. output | 12 V – 40 A |
| Cooling system | Water cooling with thermostat |
| Exhaust system | Water exhaust |
| Spark plugs | ZFR6K-11 (NGK) KJ20DR-M11 (DENSO) |
| Fuel pump | Low pressure side: mechanical type High pressure side: electrical type |
| Fuel | Unleaded gasoline (86 pump octane or higher) |
| Gear change | Forward-Neutral-Reverse (dog type) |
| Steering angle | 30° right and left |
| Tilt up angle (when transom angle at 12°) | Stageless (72°) |
| Trim angle (when transom angle at 12°) | – 4° to 16° |

Tune Up

| | | |
|---------------------------|---|--------------------|
| Spark plug gap | 0.039 – 0.043 in (1.0 – 1.1 mm) | See page 75 |
| Idle speed | 750 ± 50 rpm | See service manual |
| Valve clearance (cold) | Intake: 0.23 ± 0.02 mm Exhaust: 0.30 ± 0.02 mm | See service manual |
| Other specifications | No other adjustment is needed | |

* Without battery cable, with propeller

These TOHATSU outboard motors are power rated in accordance with NMMA procedures and using the ICOMIA standard 28/23.

TECHNICAL INFORMATION

Specifications

| MODEL | BFT150A | | |
|--|---|-----------------------|---------------------|
| Description code | BANJ | | BAPJ |
| Type | LA | XA | XCA |
| Overall length | 33.3 in (845 mm) | | |
| Overall width | 22.8 in (580 mm) | | |
| Overall height | 65.6 in (1,665 mm) | 70.5 in (1,790 mm) | |
| Transom height (when transom angle at 12°) | 20.0 in (508 mm) | 25.0 in (635 mm) | |
| Dry mass [weight]* | 478 lbs (217 kg) | 485 lbs (220 kg) | 492 lbs (223 kg) |
| Rated power | 111.9 kW (150 HP) | | |
| Full throttle range | 5,000 – 6,000 rpm | | |
| Engine type | 4 stroke DOHC in-line 4-cylinder | | |
| Displacement | 143.6 cu-in (2,354 cm ³) | | |
| Spark plug gap | 0.039 – 0.043 in (1.0 – 1.1 mm) | | |
| Starter system | Electric starter | | |
| Ignition system | Fully transistorized, battery ignition | | |
| Lubrication system | Trochoid pump pressure lubrication | | |
| Specified oil | Engine: API standard (SG, SH, SJ) SAE 10W-30 Gear case: API standard (GL-4) SAE 90 Hypoid gear oil | | |
| Oil capacity | Engine: 6.9 US qt (6.5 L) without oil filter change 7.1 US qt (6.7 L) with oil filter change Gear case: 1.04 US qt (0.98 L) | | |

| | |
|---|---|
| CARB star label | ULTRA · LOW EMISSION |
| D.C. output | 12 V – 40 A |
| Cooling system | Water cooling with thermostat |
| Exhaust system | Water exhaust |
| Spark plugs | ZFR6K-11 (NGK) KJ20DR-M11 (DENSO) |
| Fuel pump | Low pressure side: mechanical type High pressure side: electrical type |
| Fuel | Unleaded gasoline (86 pump octane or higher) |
| Gear change | Forward-Neutral-Reverse (dog type) |
| Steering angle | 30° right and left |
| Tilt up angle (when transom angle at 12°) | Stageless (72°) |
| Trim angle (when transom angle at 12°) | – 4° to 16° |

Tune Up

| | | |
|---------------------------|---|--------------------|
| Spark plug gap | 0.039 – 0.043 in (1.0 – 1.1 mm) | See page 75 |
| Idle speed | 750 ± 50 rpm | See service manual |
| Valve clearance (cold) | Intake: 0.23 ± 0.02 mm Exhaust: 0.30 ± 0.02 mm | See service manual |
| Other specifications | No other adjustment is needed | |

* Without battery cable, with propeller

These TOHATSU outboard motors are power rated in accordance with NMMA procedures and using the ICOMIA standard 28/23.

CONSUMER INFORMATION

Emission Control System Warranty

Your new Tohatsu outboard engine complies with both the U.S. EPA and State of California emission regulations. Tohatsu Corporation provides the same emission warranty coverage for outboard engines sold in all 50 states. In all areas of the United States your outboard engine must be designed, built, and equipped to meet the U.S. EPA and California Air Resources Board emission standard for spark ignited marine engines.

APPLICABILITY

This emission control system warranty is applicable to the following models only:
BFT60A/BFW60A, BFT75A/BFT90A, BFT115A/
BFT150A, BFT200A/BFT225A and BFT250A

CALIFORNIA EMISSIONS CONTROL WARRANTY STATEMENT YOUR WARRANTY RIGHTS AND OBLIGATIONS

The California Air Resources Board (CARB) and Tohatsu Corporation are pleased to explain the emission control system warranty on your 2018 Tohatsu outboard engine. In California, new outboard engines must be designed, built, and equipped to meet the state's stringent anti-smog standards.

Tohatsu Corporation must warrant the emission control system on your outboard engine for the periods of time listed below provided there has been no abuse, neglect, or improper maintenance of your outboard engine.

Your emission control system may include parts such as the carburetor or fuel injection system, the ignition system, catalytic converter, canisters, clamps, filters, fuel caps, fuel lines, fuel tanks, valves, and vapor hoses. Also included may be hoses, belts, connectors, and other emission-related assemblies.

Where a warrantable condition exists, Tohatsu Corporation will repair your outboard engine at no cost to you including diagnosis, parts, and labor.

CONSUMER INFORMATION

MANUFACTURER'S WARRANTY COVERAGE:

Select emission control parts from model year 2010 and later outboard engines are warranted for five years or 250 hours of use, whichever first occurs; or the length of the Tohatsu Limited Warranty Information, whichever is longer. The evaporative emission control system from model year 2010 and later outboard engines are warranted for two years with no limit on hours of use, or the length of the Tohatsu Limited Warranty Information, whichever is longer, from the date of delivery to the retail purchaser. However, warranty coverage based on the hourly period is only permitted for engines equipped with hour meters as defined in § 2441 (a)(13)* or their equivalent. If any emission-related part on your engine is defective under warranty, the part will be repaired or replaced by Tohatsu Corporation. See the Emission Control System Warranty Parts table on page 117 for parts description.

* California Code of Regulations

OWNER'S WARRANTY RESPONSIBILITIES:

As the outboard engine owner, you are responsible for the performance of the required maintenance listed in your owner's manual.

Tohatsu Corporation recommends that you retain all receipts covering maintenance on your outboard engine, but Tohatsu Corporation cannot deny warranty solely for the lack of receipts or your failure to ensure the performance of all scheduled maintenance.

As the outboard engine owner, you should, however, be aware that Tohatsu Corporation may deny you warranty coverage if your outboard engine or a part has failed due to abuse, neglect, improper maintenance, or unapproved modifications.

You are responsible for presenting your outboard engine to a Tohatsu authorized dealer as soon as a problem exists. The warranty repairs will be completed in a reasonable amount of time, not to exceed 30 days.

If you have any questions regarding your warranty rights and responsibilities, you should contact

Tohatsu America Corporation
670 South Freeport Parkway
Suite 120 Coppell, TX 75019
Telephone: (214) 420-6440

WARRANTY COVERAGE:

See Manufacturer's Warranty Coverage above for warranty coverage terms. This warranty is transferred to each subsequent purchaser for the duration of the warranty period. Warranty repairs will be made without charge for diagnosis, parts, and labor. All defective parts replaced under this warranty become the property of Tohatsu Corporation. A list of warranty parts is on page 117. Normal maintenance items, such as spark plugs and filters, that are on the warranted parts list are warranted up to their required replacement interval only. Tohatsu Corporation is also liable for damages to other engine components caused by a failure of any warranted part during the warranty period.

Only Tohatsu Corporation approved replacement parts will be used in the performance of any warranty repairs, and they will be provided without charge to the owner. You may use any replacement part as defined in § 1900 (b)(20)* in the performance of any maintenance or repairs. Tohatsu cannot deny coverage under the emission warranty solely for use of non-Tohatsu replacement parts or service performed at a location other than an authorized Tohatsu dealership; however, use of a part that is not functionally identical to the original equipment part in any respect that may in any way affect emissions (including

durability) could result in denial of coverage.

If a non-Tohatsu replacement part is used in the repair or maintenance of your engine, and an authorized Tohatsu dealer determines it causes the failure of a warranted part, your warranty claim may be denied. If the part in question is not related to the reason that your engine requires repair, your claim will not be denied.

* California Code of Regulations

TO OBTAIN WARRANTY SERVICE:

You must take your Tohatsu outboard engine, along with your warranty registration card or other proof of original purchase date, at your expense, to any Tohatsu dealer that is authorized by Tohatsu Corporation to sell and service that Tohatsu product during its normal business hours. Claims for repair or adjustment found to be caused solely by defects in material or workmanship will not be denied because the engine was not properly maintained and used. If you are unable to obtain warranty service, or are dissatisfied with the warranty service you received, contact the owner of the dealership involved. Normally this should resolve your problem. However, if you require further assistance, write or call Tohatsu Corporation.

CONSUMER INFORMATION

EXCLUSIONS:

Failures other than those resulting from defects in material or workmanship are not covered by this warranty. This warranty does not extend to emission control systems or parts which are affected or damaged by owner abuse, neglect, improper maintenance, misuse, misfueling, improper storage, and/or collision, the incorporation of, or use of, unsuitable attachments, or the unauthorized alteration of any part.

This warranty does not cover replacement of expendable maintenance items made in connection with required maintenance service after the items first scheduled replacement as listed in the maintenance section of the product (outboard motor) owner's manual, such as: spark plugs and filters.

DISCLAIMER OF CONSEQUENTIAL DAMAGE AND LIMITATION OF IMPLIED WARRANTIES:

Tohatsu Corporation disclaims any responsibility for incidental or consequential damages such as loss of time or the use of outboard engine, or any commercial loss due to the failure of the equipment; and any implied warranties are limited to the duration of this written warranty. This warranty is applicable only where the California or U.S. EPA emission control system warranty regulation is in effect.

CONSUMER INFORMATION

EMISSION CONTROL SYSTEM WARRANTY PARTS:

| SYSTEMS COVERED BY THIS WARRANTY: | PARTS DESCRIPTION: | LENGTH OF WARRANTY: |
|---|--|---|
| Evaporative | Portable fuel tank, Outboard internal fuel tank, Fuel cap, Fuel hoses, Fuel hose joint, Vapor separator, and Carbon canister, All other parts not listed that may affect the evaporative emissions control system | Five years or 250 hours of use, whichever first occurs; or the length of the Tohatsu Limited Warranty Information, whichever is longer. |
| Fuel Metering | Carburetor assembly, Throttle body, Fuel injector, Fuel pump, Fuel pressure regulator, Throttle position sensor, Intake air temperature sensor, Engine temperature sensor, Manifold absolute pressure sensor, Idle air control valve, Barometric pressure sensor, Fuel line solenoid valve, Intake manifold, Intake valves, and Oxygen sensor or Air fuel ratio sensor | |
| Air Induction | Air intake duct, Intake manifold tuning valve (Intake air bypass control valve) | |
| Ignition | Flywheel magneto, Ignition pulse generator, Ignition coil assembly, Ignition control module, Engine control module, Crankshaft position sensor, Spark plug cap, Spark plug*, Knock sensor, and Camshaft position sensor | |
| Lubrication System | Oil pump and internal parts | |
| Crankcase Emission Control | Crankcase breather tube, Positive crankcase ventilation valve, Oil filler cap | |
| Exhaust | Exhaust manifold and Exhaust valves | |
| Valve Control System | Rocker arm oil control valve | |
| Miscellaneous Parts | Tubing, fittings, seals, gaskets, and clamps associated with these listed systems. | |
| * Covered up to the first required replacement only. See the <i>Maintenance Schedule</i> on page 62 and 63. | | |

INDEX

| | | | |
|---------------------------------------|-----|---|--------|
| Alternator (ACG) Indicator | 33 | Electric Starter Will Not Operate | 93, 98 |
| Anodes | 36 | Emergency Stop Switch Clip and Emergency Stop Switch | |
| Replacement | 83 | Panel-Mount Type | 19 |
| ARE YOU READY TO GET UNDERWAY? | 37 | Side-Mount Type | 15 |
| Battery | 106 | Top-Mount Type | 22 |
| Will Not Charge | 98 | Emission Control System Information | 106 |
| BEFORE OPERATION | 37 | Emission Control System Warranty | 113 |
| BREAK-IN PROCEDURE | 39 | Engine | |
| CLEANING AND FLUSHING | 85 | Cover | |
| Common Controls | 26 | Latch | 28 |
| COMPONENT AND CONTROL LOCATIONS | 11 | REMOVAL AND INSTALLATION | 65 |
| CONSUMER INFORMATION | 113 | Oil | |
| CONTROL AND FEATURE IDENTIFICATION | | Change | 67 |
| CODES | 10 | Filter Change | 69 |
| CONTROLS | 15 | Level Check | 66 |
| CONTROLS AND FEATURES | 10 | Recommendations | 70 |
| Cooling System Indicator | 35 | OVERHEATS | 97 |
| CRUISING | 53 | WILL NOT START | 94 |

| | | | |
|---|----|--|--------|
| Fast Idle Button | | Ignition Switch | |
| Panel-Mount Type | 21 | Panel-Mount Type | 18 |
| Top-Mount Type | 25 | Side-Mount Type | 15 |
| Fast Idle Lever | 17 | Top-Mount Type | 22 |
| Fuel | | IMPORTANT SAFETY INFORMATION | 7 |
| PRIMING | 40 | INDICATORS | 33 |
| Priming Bulb | 36 | INFREQUENT OR OCCASIONAL USE | 40 |
| Fuel | | INSTRUMENTS | 29 |
| RECOMMENDATIONS | 77 | IS YOUR OUTBOARD MOTOR | |
| Filter Inspection and Replacement | 78 | READY TO GO? | 37 |
| Fuse Replacement | 98 | | |
| FUSES | 98 | Lubrication Points | 71 |
| | | MAINTENANCE SAFETY | 60 |
| Gearshift/Throttle Control Lever | | MAINTENANCE SCHEDULE | 62 |
| Panel-Mount Type | 20 | Malfunction Indicator | 33 |
| Side-Mount Type | 16 | MANUAL RELIEF VALVE | 27, 65 |
| Top-Mount Type | 23 | MOORING, BEACHING, LAUNCHING | 57 |
| GEARSHIFT AND THROTTLE OPERATION | 51 | MULTIPLE OUTBOARD MOTORS | 58 |
| | | | |
| HARD STARTING OR STALLS AFTER | | NMEA 2000 [®] Interface Coupler | 30 |
| STARTING | 96 | | |
| HOISTING THE OUTBOARD MOTOR | 90 | | |

INDEX

| | | | |
|---|-----|--|-----|
| Oil Pressure Indicator | 34 | SPARE EMERGENCY STOP SWITCH CLIP | 61 |
| OIL PRESSURE INDICATOR TURNS OFF AND ENGINE SPEED IS LIMITED | 100 | Spark Plug Service | 73 |
| OPERATION | 39 | Specifications | 111 |
| Operating Hour Notification System | 30 | Star Label | 109 |
| OTHER FEATURES | 35 | STARTING THE ENGINE | 41 |
| OUTBOARD MOTOR SAFETY | 7 | Panel-Mount Type | 44 |
| Overheat Indicator | 34 | Side-Mount Type | 41 |
| OVERHEAT INDICATOR COMES ON AND ENGINE SPEED IS LIMITED | 101 | Top-Mount Type | 46 |
| Power Tilt Switch | 27 | STEERING | 52 |
| Power Trim/Tilt Switch | 26 | STOPPING THE ENGINE | 49 |
| Propeller Replacement | 83 | Emergency Engine Stopping | 49 |
| REFUELING | 77 | Normal Engine Stopping | 50 |
| REMOVAL FROM STORAGE | 91 | STORAGE | 87 |
| Rev Limiter | 36 | Engine oil | 89 |
| SAFE OPERATING PRECAUTIONS | 39 | Fuel | 87 |
| SAFETY LABEL LOCATION | 9 | STORAGE PRECAUTIONS | 90 |
| Serial Number Locations | 105 | SUBMERGED OUTBOARD MOTOR | 103 |
| SERVICING YOUR OUTBOARD MOTOR | 59 | | |
| SHALLOW WATER OPERATION | 56 | | |

| | |
|--|-----|
| Tachometer (optional equipment) | 29 |
| TAKING CARE OF UNEXPECTED PROBLEMS | 93 |
| TECHNICAL INFORMATION | 105 |
| THE IMPORTANCE OF MAINTENANCE | 59 |
| Tilt Lock Lever | 27 |
| TOOL KIT and OWNER'S MANUAL | 61 |
| TRANSPORTING | 92 |
| WITH OUTBOARD MOTOR INSTALLED | |
| ON BOAT | 92 |
| WITH OUTBOARD MOTOR REMOVED | |
| FROM BOAT | 92 |
| Trim Meter (optional equipment) | 29 |
| Trim Tab | 29 |
| TRIM TAB ADJUSTMENT | 64 |
| TRL (Trolling) Control Switch..... | 28 |
| Trolling Speed Control | 55 |
| | |
| Water Separator Buzzer | 35 |
| WATER SEPARATOR BUZZER SOUNDS | 103 |
| Water Separator Inspection and Service | 81 |

© 2017 Honda Motor Co., Ltd. – All Rights Reserved
PGM-FI is a trademark of Honda Motor Co., Ltd.
registered in Japan and other countries.

OWNER'S MANUAL

BFT 115A
BFT 150A

TOHATSU CORPORATION

5-4, Azusawa 3-Chome, Itabashi - Ku
Tokyo 174-0051, Japan

Tel: +81-3-3966-3117 Fax: +81-3-3966-2951

www.tohatsu.com



31ZX1T12
00X31-ZX1-T120

 **PRINTED IN JAPAN**